



COMELETRIC

Specialized rotary and control switches

series R20-DR20





R20 General Information R20 Informazioni Generali.....	3-4
R101 Model Modello R101.....	5
R102 Model Modello R102.....	6
R103 Model Modello R103.....	7
R126 Model Modello R126.....	8
R110 Model Modelli R110.....	9
R141 Model Modello R141.....	10
R104 PUSH / R107 PULL Model Modello R104 PUSH / R107 PULL.....	11
SR109 Model Modello R109.....	12
Switch functions and configurations Funzione e configurazione commutatori.....	13-34
BR001 Model Modello BR001.....	35-36
Front dimensions Dimensione frontali.....	37-38
DR110 / DR115 Model Modello DR110 / Modello DR115.....	39-40
DS functions and configurations Funzione e configurazione manipolatori.....	41-45
Accessories Accessori.....	46
Technical data Dati tecnici.....	47-48
Custom made models Modelli speciali.....	49



Double bridge Rotor contact Knife type
Fixed contacts with self-cleaning effect.
Contatto mobile a doppio ponte contatti fissi
a coltello con effetto strisciante autopulente.

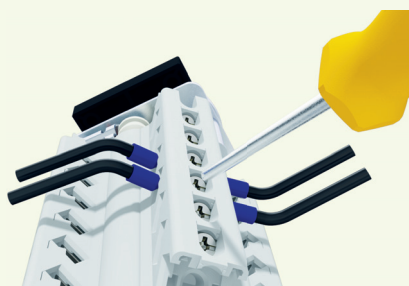

IP20 terminal screw with two entries.
Easy access to screws even
when the switch is wired.
Morsetto con protezione IP20 a doppio
ingresso. L'accesso alla vite garantito anche
a commutatore cablato.



Terminal easy to access from the rear of the
switch thanks to the inclined screw 45°.
Morsetto con viti inclinate a 45° facilità di accesso
al morsetto anche dal retro del commutatore.

R20 OFFERS ONLY ADVANTAGES

- The switches/discrepancy switches "R20-DR20" have special characteristics that make them very different from the normal switches on the market.
Listed below are some of the many advantages they provide.
- Contact system with self-cleaning action on both sides of contact, suitable for being used in highly aggressive environments, with presence of high percentage of saline dust and corrosive agents.
- High resistance to shock and vibration, due to the clip and blade contact design.
- Terminals with protection IP20 according to IEC 60529 with two entries.
- Easy access to the screws of each terminal even when the switch is wired.
- High mechanical strength, shaft and main structure in zinc plated steel, suitable for tropical climates.

- Terminals screws at 45° for ease of access.
- Last generation polymer with high mechanical strength and excellent electrical characteristics.
Self-extinguishing UL94V0.

R20 OFFRE SOLO VANTAGGI

- I commutatori / manipolatori serie "R20-DR20" hanno caratteristiche particolari che li rendono molto differenti dai commutatori comunemente in commercio, elenchiamo di seguito quali sono ed i vantaggi che garantiscono.
- Sistema contatto strisciante con effetto autopulente su entrambe le superfici di contatto particolarmente idonei ad essere utilizzati in ambienti altamente aggressivi presenza di polvere alto tasso salino ecc.
- Elevata resistenza a Shock e Vibrazioni. Poiché il contatto fisso è posizionato tra le due lame, il contatto viene premuto su una lama nel caso la forza sull'altra diminuisca.
- Morsetti con protezione IP20 in conformità alla normativa IEC 60529 con doppio ingresso.
- Accesso alla vite del singolo morsetto anche a commutatore cablato per facilitare le operazioni di manutenzione.
- Elevata robustezza meccanica, albero e struttura portante interamente in acciaio zincato elettroliticamente, idoneo ad essere montato anche in zone tropicali.
- Morsetti con viti inclinate a 45° per accessi difficoltosi (facilità di accesso al morsetto anche dal retro del commutatore).
- Tecnopolimero di ultima generazione con ottima resistenza meccanica, elevate caratteristiche elettriche ed autoestinguento UL94V0.

■ Wide range of accessories available.

■ Captive plus/minus terminal screws M3.5.

■ Terminals supplied opened for fast and easy installation.

■ Double choice of location of the cables. Possibility of wiring horizontally or vertically on a single model of switch.

■ Numbered plastic cover, customizable and replaceable in case of failure without removing the wires to the switch.

■ Geometric body insulation allows economizing space allowing close mounting of switches.

■ A wide range of realizable switching schemes.

■ Same parts used for base or panel mounting (upside down mounting).

■ Up to 23 packets of contacts assembled in a single switch.

■ 2/3 positions switch with the possibility of an internal common (avoids external bridges).

■ Ampia gamma di accessori disponibili.

■ Vite M3.5 con cavaliere serrafilo autosollevante e viti captive taglio +/-.

■ Terminali forniti aperti per velocizzare le operazioni di cablaggio.

■ Doppia scelta di ubicazione dei cavi con possibilità di cablaggi verticali ed orizzontali in un unico commutatore.

■ Tegolino con numerazione morsetti personalizzabile e sostituibile in caso di errore senza scablare il commutatore.

■ Geometria dell'isolante permette una economicizzazione degli spazi permettendo il montaggio ravvicinato dei commutatori.

■ Ampia gamma di schemi elettrici realizzabili

■ Stesse parti utilizzate per fissaggio base o fissaggio retroquadro (montaggio ribaltato).

■ Fino a 23 pacchi di contatti assemblati in un unico commutatore.

■ Commutatori a 2/3 posizioni con possibilità di comune interno (evita di eseguire ponti esterni).

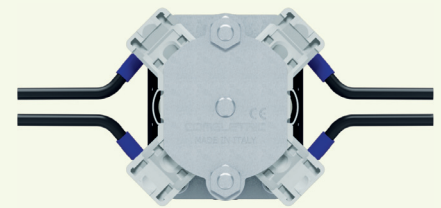

Horizontal Wiring
Cablaggio orizzontale dei cavi.



Vertical Wiring
Cablaggio verticale dei cavi

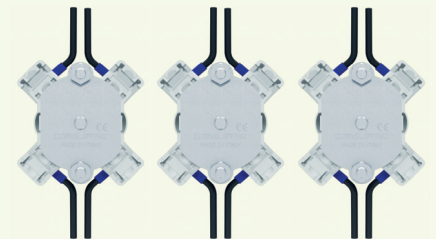

Double access to terminals allows close mounting of switches.
Possibilità di montaggio ravvicinato dei commutatori grazie al morsetto con doppia accessibilità.

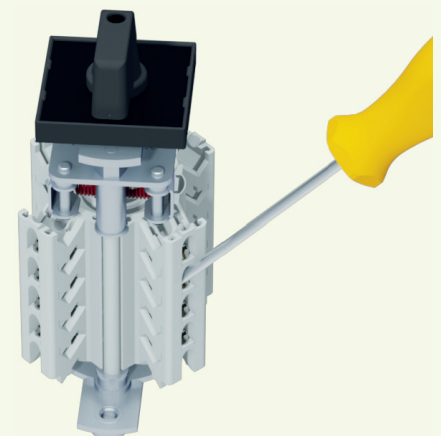

Same parts used for base or panel mounting (upside down mounting).
Per il Commutatore Base Mounting vengono utilizzate le medesime parti ma montate up-side down

R101 Model:

It can have from 2 to 8 positions fixed or with automatic return.

It may be supplied with frontplate size 48X48mm (Q4) or 64X64mm (Q7) Standard Type or Padlockable.

Realizza da 2 a 8 posizioni sia fisse che con molla di ritorno.

Può essere fornito con mostrina frontale 48x48mm (Q4) o 64x64mm (Q7) in versioni standard o Lucchettabili.

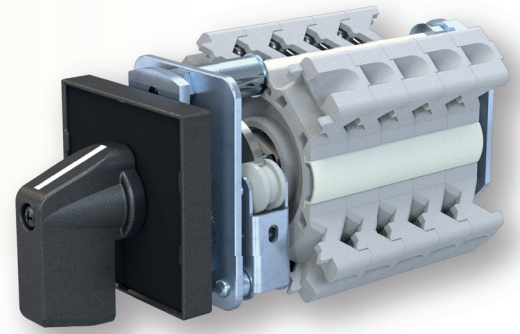

Dimensions

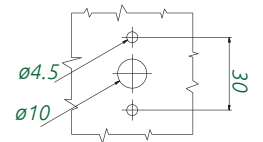
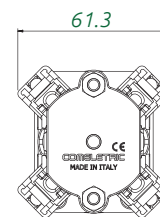
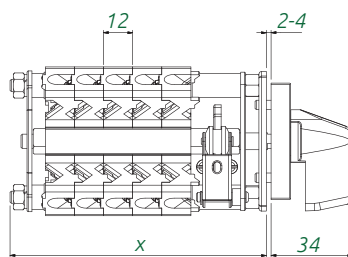
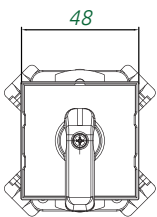

N° of packets	1	2	3	4	5	6	7	8	9	10	11	12	13	14	15
Length (mm)	69	81	93	105	117	129	141	153	165	177	189	201	213	225	237

Max 23 p.

R101 Frontplates R101 Mostrine

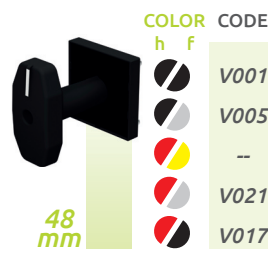
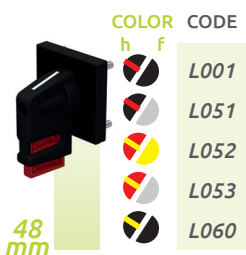
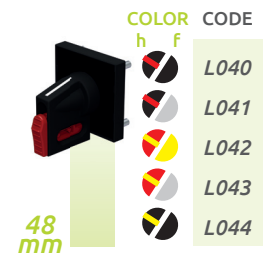
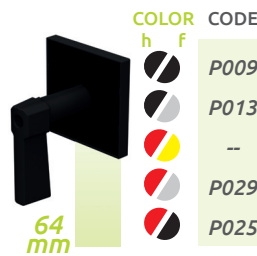
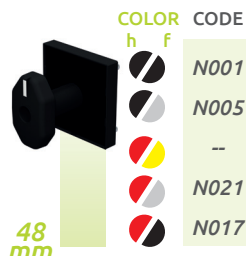
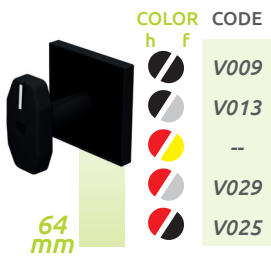
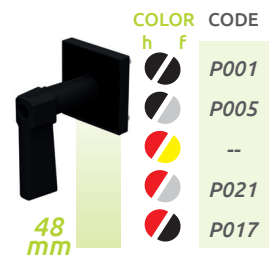
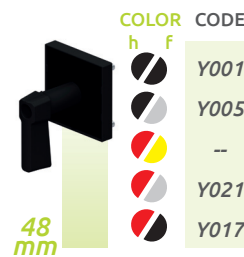
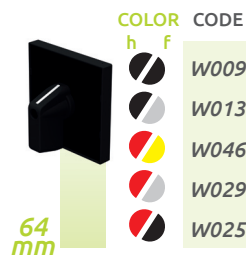
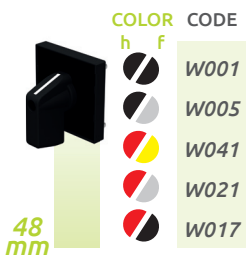

h=handle; f=frontplate
h=manopola; f=mostrina
Frontplate dimension on page 37/38
Dimensioni frontali a pag. 37/38

R102 Model:

Key Operated rotary switch.
Available with keys equal to each other and up to 200 different combinations.

Commutatore con operatore a chiave
Disponibile con chiavi uguali tra loro e fino a 200 combinazioni diverse tra loro.

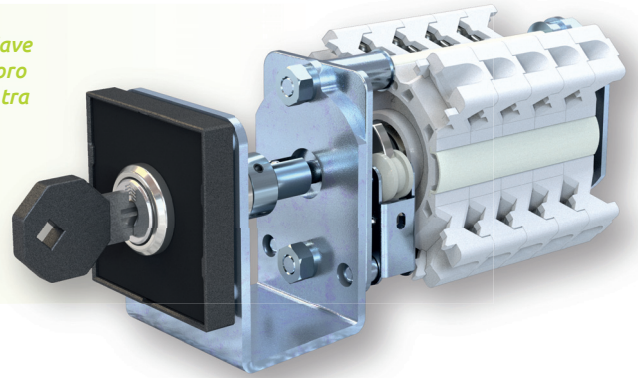

Dimensions

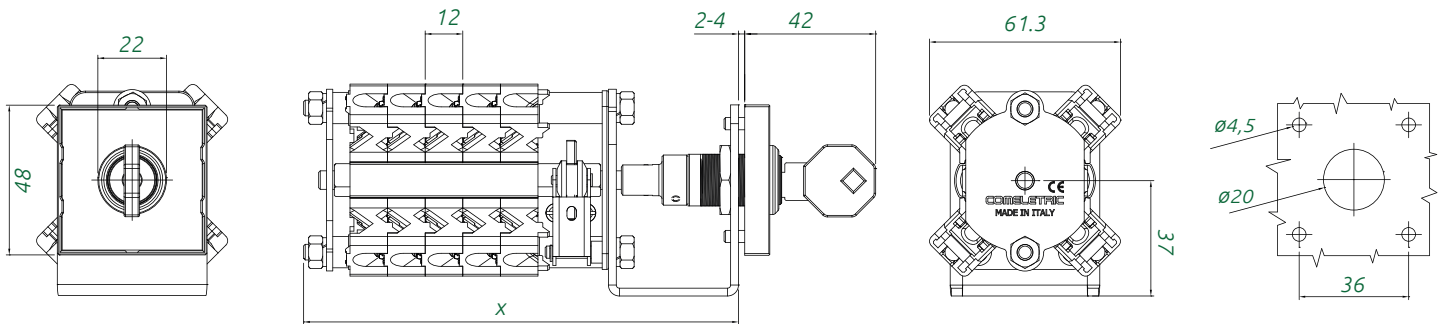

Panel Drilling

N° of packets	1	2	3	4	5	6	7	8
Length (mm)	102	114	126	138	150	162	174	186

R102 Frontplates R102 Mostrine

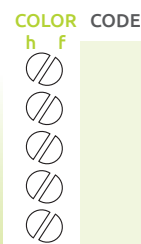
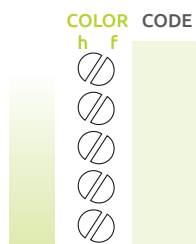
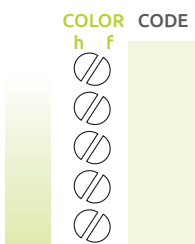
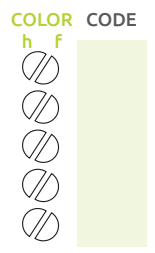
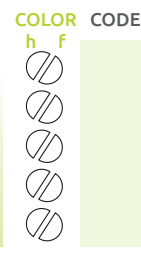

h=handle; f=frontplate
h=manopola; f=mostrina
Frontplate dimension on page 37/38
Dimensioni frontali a pag. 37/38

R103 Model:

Key Lock rotary switch.

Available with keys, that can be both equals or different one from the other (up to 500 different numbers).

MASTER KEY System is also available.

Commutatore con serratura di blocco.

Disponibile con chiavi uguali tra loro o fino a 500 combinazioni diverse tra loro.

Disponibile anche con MASTER KEY.

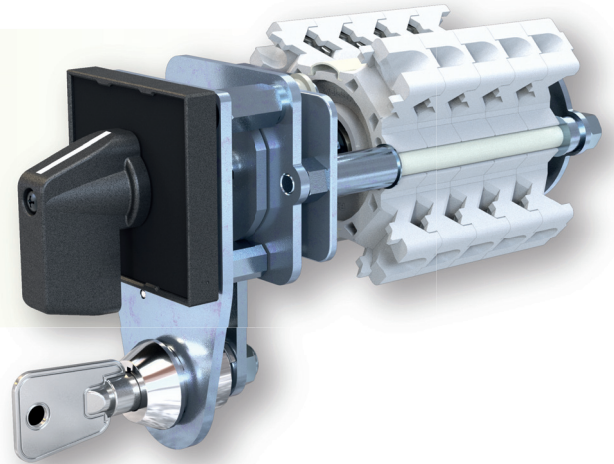

Dimensions

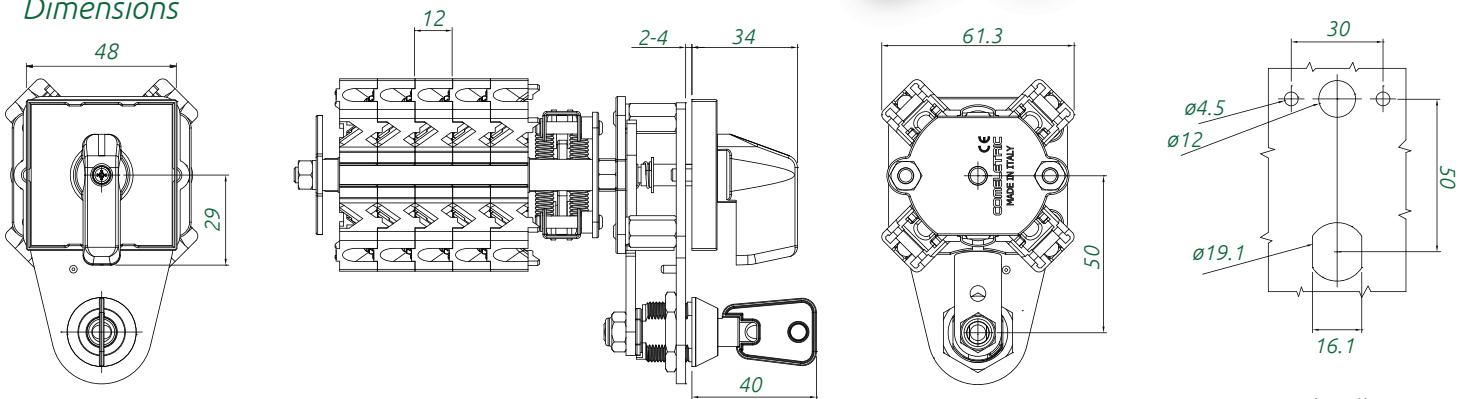

Panel Drilling

N° of packets	1	2	3	4	5	6	7	8	9	10	11	12	13	14	15
Length (mm)	89	101	113	125	137	149	161	173	185	197	209	221	233	245	257

Max 23 p.

R103 Frontplates R103 Mostrine

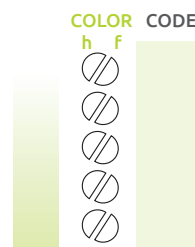
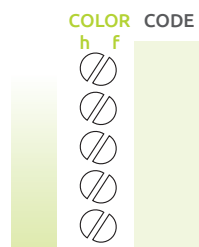
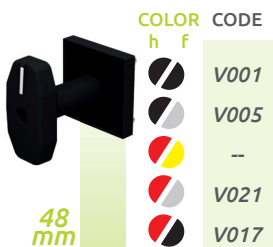
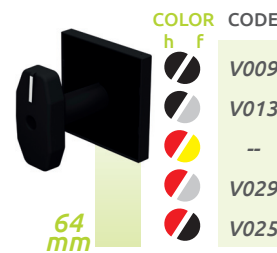
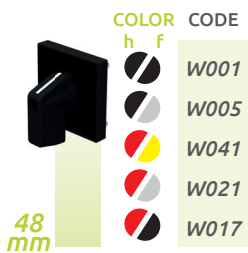

h=handle; f=frontplate
h=manopola; f=mostrina
Frontplate dimension on page 37/38
Dimensioni frontali a pag. 37/38

R126 Model:

The Mechanical trip Indicator shows the indication of the last given command.

Il dispositivo meccanico di avvenuta manovra indica l'ultimo comando effettuato dal commutatore.

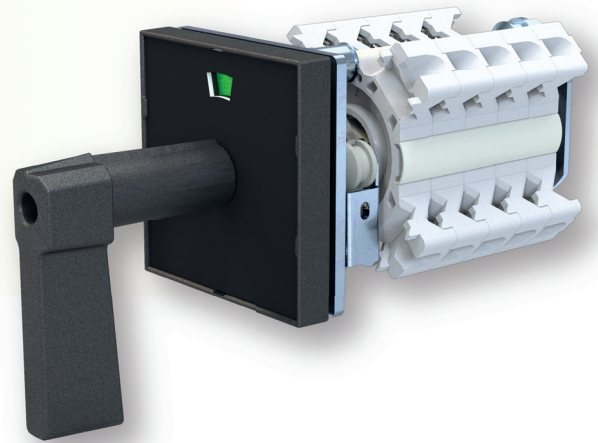

Dimensions

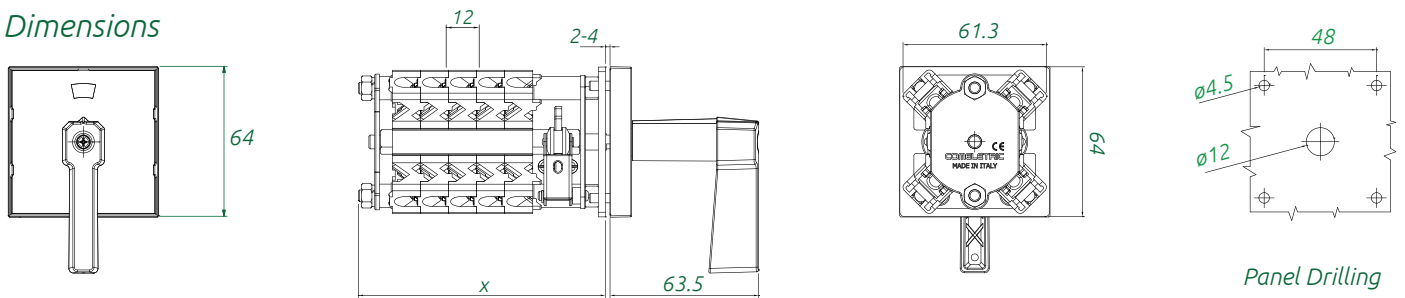

N° of packets	1	2	3	4	5	6	7	8	9	10	11	12	13	14	15
Length (mm)	69	81	93	105	117	129	141	153	165	177	189	201	213	225	237

Max 23 p.

R126 Frontplates R126 Mostrine

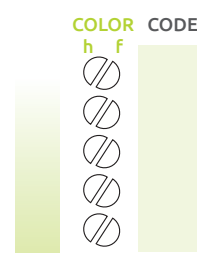
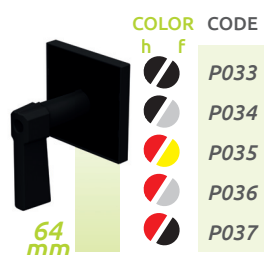
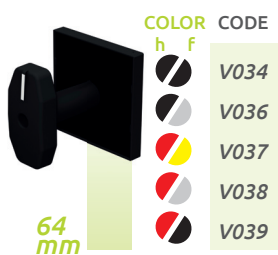
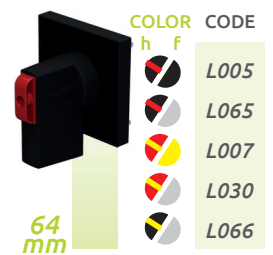
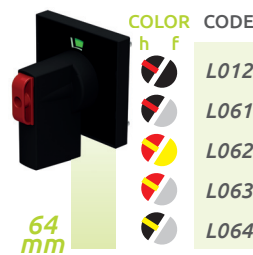
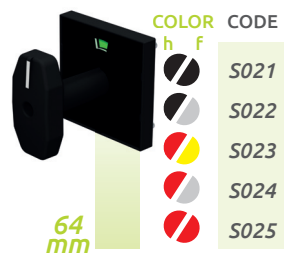

h=handle; f=frontplate
h=manopola; f=mostrina
Frontplate dimension on page 37/38
Dimensioni frontali a pag. 37/38

R110 Models:

Switch with removable handle is mainly used for Safety controls.

Commutatore con manopola asportabile adatto per comandi di sicurezza.

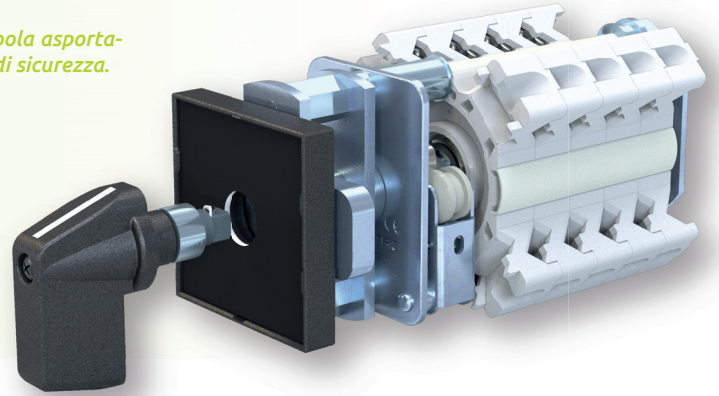

Dimensions

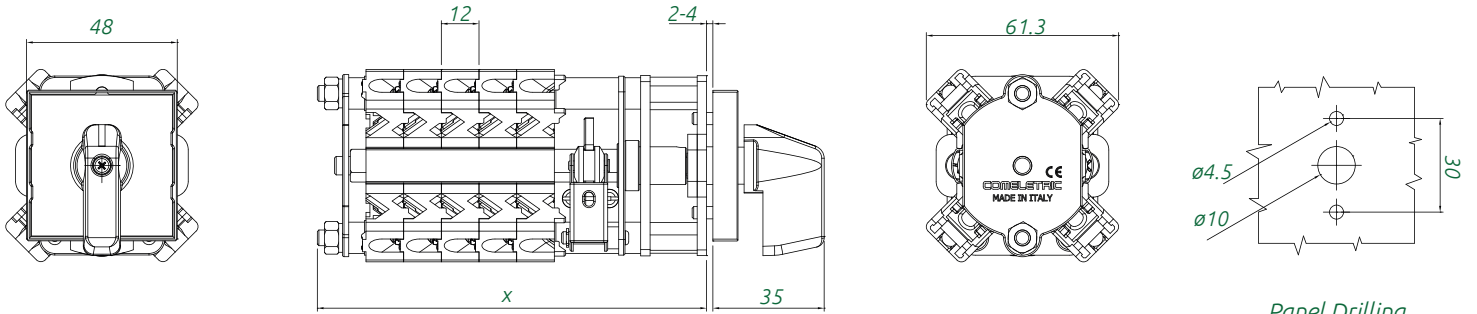

Panel Drilling

N° of packets	1	2	3	4	5	6	7	8	9	10	11	12
Length (mm)	89	101	113	125	137	149	161	173	195	197	209	221

Max 23 p.

R110 Frontplates R110 Mostrine

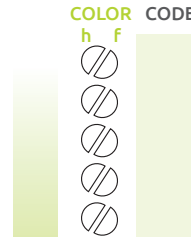
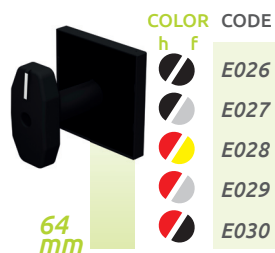
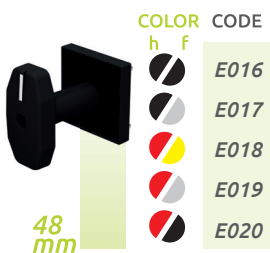
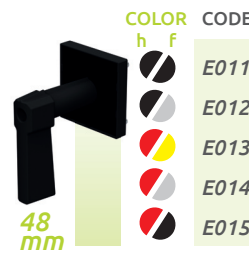
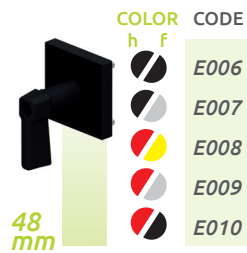

h=handle; f=frontplate
 h=manopola; f=mostrina
 Frontplate dimension on page 37/38
 Dimensioni frontali a pag. 37/38

R141 Model:

Switch suitable for fitting at the bottom of the panel.
Access to screw from the front of the switch.

Commutatore idoneo al montaggio sul fondo del quadro.
L'accesso alle viti avviene dal fronte del commutatore.

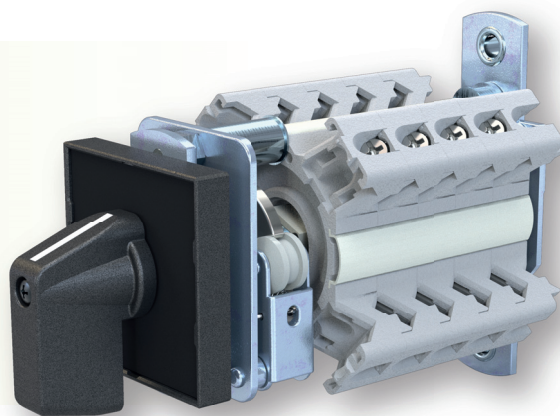

Dimensions

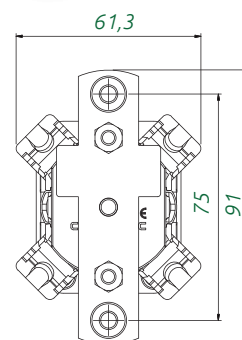
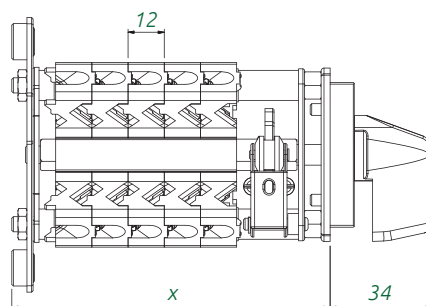
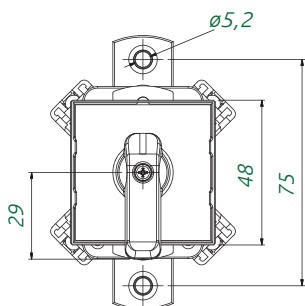

N° of packets	1	2	3	4	5	6	7	8	9	10	11	12
Length (mm)	70	82	94	106	118	130	142	154	166	178	190	202

R141 Frontplates R141 Mostrine

COLOR CODE

h	f	CODE
Black	Black	W001
Black	Grey	W005
Red	Yellow	W041
Red	Grey	W021
Red	Black	W017

48 mm

COLOR CODE

h	f	CODE
Black	Black	W009
Black	Grey	W013
Red	Yellow	W046
Red	Grey	W029
Red	Black	W025

64 mm

COLOR CODE

h	f	CODE
Black	Black	Y001
Black	Grey	Y005
Red	Yellow	--
Red	Grey	Y021
Red	Black	Y017

48 mm

COLOR CODE

h	f	CODE
Black	Black	P001
Black	Grey	P005
Red	Yellow	--
Red	Grey	P021
Red	Black	P017

48 mm

COLOR CODE

h	f	CODE
Black	Black	V009
Black	Grey	V013
Red	Yellow	--
Red	Grey	V029
Red	Black	V025

64 mm

COLOR CODE

h	f	CODE
Black	Black	N001
Black	Grey	N005
Red	Yellow	--
Red	Grey	N021
Red	Black	N017

48 mm

COLOR CODE

h	f	CODE
Black	Black	P009
Black	Grey	P013
Red	Yellow	--
Red	Grey	P029
Red	Black	P025

64 mm

COLOR CODE

h	f	CODE
Black	Black	L040
Black	Grey	L041
Red	Yellow	L042
Red	Grey	L043
Red	Black	L044

48 mm

COLOR CODE

h	f	CODE
Black	Black	L001
Black	Grey	L051
Red	Yellow	L052
Red	Grey	L053
Red	Black	L060

48 mm

COLOR CODE

h	f	CODE
Black	Black	Y009
Black	Grey	Y013
Red	Yellow	--
Red	Grey	Y029
Red	Black	Y025

64 mm

COLOR CODE

h	f	CODE
Black	Black	V001
Black	Grey	V005
Red	Yellow	--
Red	Grey	V021
Red	Black	V017

48 mm

h=handle; f=frontplate
h=manopola; f=mostrina
Frontplate dimension on page 37/38
Dimensioni frontali a pag. 37/38

Models: **R104** push to operate **R107** pull to operate

This Switch is mainly used to avoid involuntary operations. It can be handled only by **PUSHING** (R104) or **PULLING** (R107) the knob of the switch.

Questo dispositivo di sicurezza serve per evitare manovre accidentali. Il commutatore può essere manovrato solamente **PREMENDO** (R104) o **TIRANDO** (R107) la manopola del commutatore.

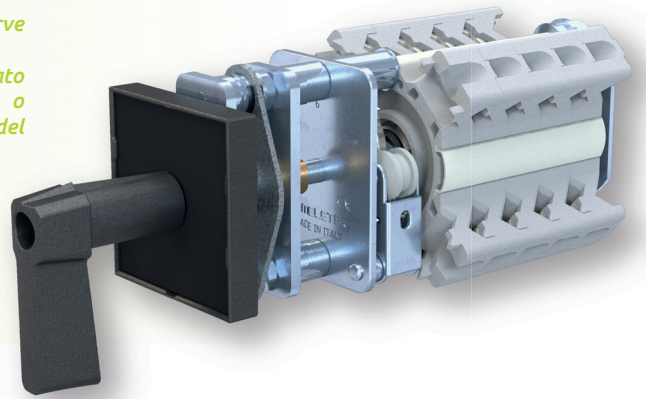

Dimensions

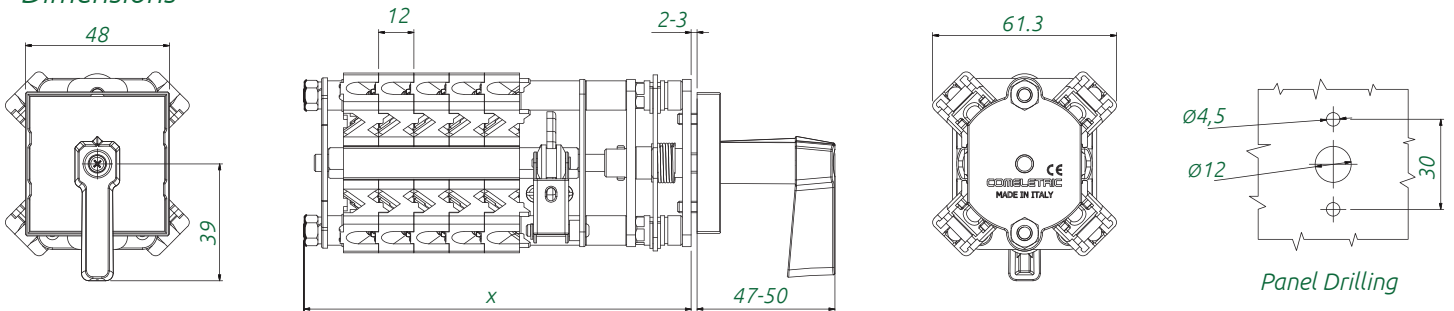

N° of packets	1	2	3	4	5	6	7	8	9	10	11	12
Length (mm)	98	110	122	134	176	158	171	182	194	206	218	230

R104 / R107 Frontplates R104 / R107 Mostrine

48 mm

COLOR	CODE
h f	
	Z001
	Z017
	--
	Z017
	--

48 mm

COLOR	CODE
h f	
	Z009
	Z041
	--
	Z025
	Z049

64 mm

COLOR	CODE
h f	
	Z084
	Z085
	Z086
	Z087
	Z088

48 mm

COLOR	CODE
h f	
	Z057
	Z080
	Z081
	Z082
	Z083

64 mm

COLOR	CODE
h f	
	Z089
	Z090
	Z091
	Z092
	Z093

COLOR	CODE
h f	

COLOR	CODE
h f	

h=handle; f=frontplate
h=manopola; f=mostrina
Frontplate dimension on page 37/38
Dimensioni frontali a pag. 37/38

SR109 Model:

Switch with electromagnetic interlocking device.
Allows manoeuvre after electric consent.
The switch is unblocked by exciting the circuit.
SOLENOIDS AT VOLTAGES:
24Vdc - 110Vdc - 220Vdc
other tensions on request.

Commutatore con elettromagnete di interblocco.
Permette la manovra dopo un consenso elettrico.
Lo sblocco del commutatore avviene eccitando il circuito.
ELETTROMAGNETI A TENSIONE:
24Vcc - 110Vcc - 220Vcc
altre tensioni su richiesta.

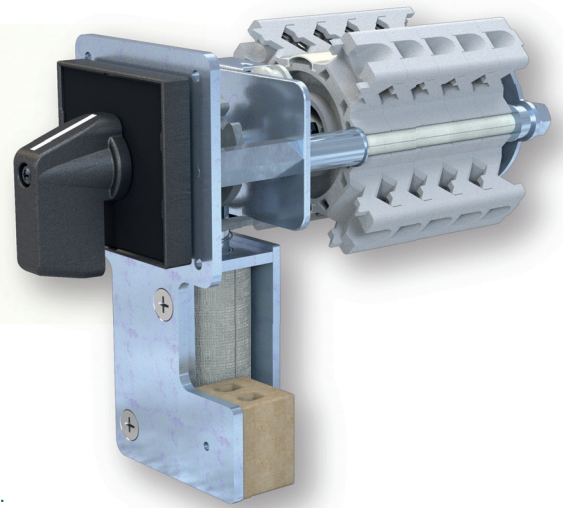







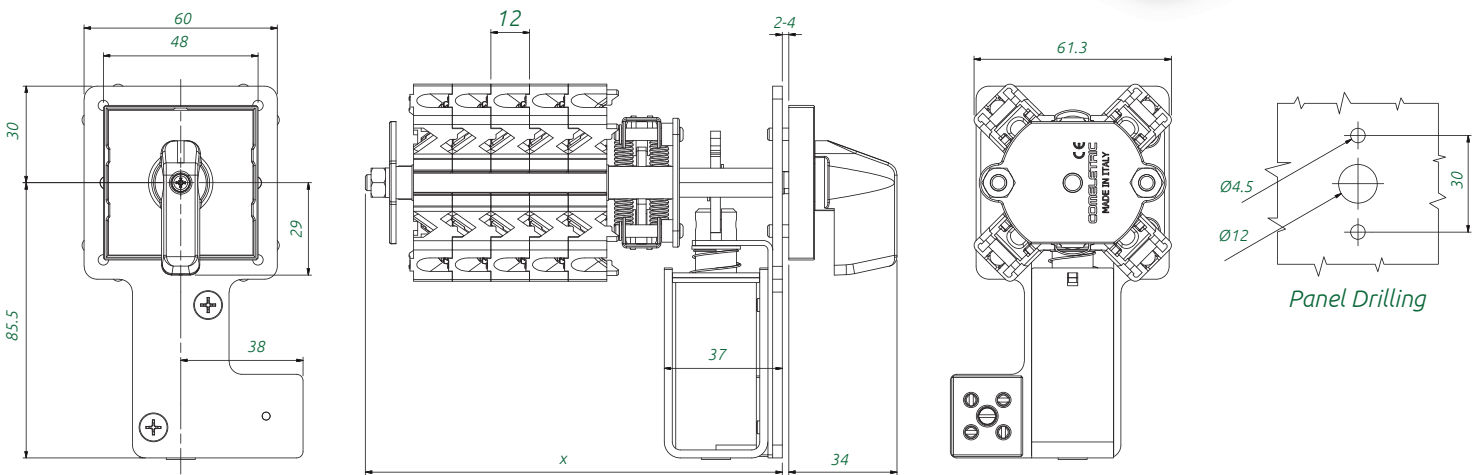

N° of packets	1	2	3	4	5	6	7	8	9	10	11	12	13	14	15
Length (mm)	69	81	93	105	117	129	141	153	165	177	189	201	213	225	237

Max 23 p.

Dimensions



SR109 Frontplates SR109 Mostrine

 <p>48 mm</p>	<p>COLOR</p> <p>h f</p> <p>W001</p> <p>W005</p> <p>W041</p> <p>W021</p> <p>W017</p>	<p>CODE</p>	 <p>64 mm</p>	<p>COLOR</p> <p>h f</p> <p>W009</p> <p>W013</p> <p>W046</p> <p>W029</p> <p>W025</p>	<p>CODE</p>	 <p>48 mm</p>	<p>COLOR</p> <p>h f</p> <p>Y001</p> <p>Y005</p> <p>--</p> <p>Y021</p> <p>Y017</p>	<p>CODE</p>	 <p>48 mm</p>	<p>COLOR</p> <p>h f</p> <p>P001</p> <p>P005</p> <p>--</p> <p>P021</p> <p>P017</p>	<p>CODE</p>
 <p>64 mm</p>	<p>COLOR</p> <p>h f</p> <p>V009</p> <p>V013</p> <p>--</p> <p>V029</p> <p>V025</p>	<p>CODE</p>	 <p>48 mm</p>	<p>COLOR</p> <p>h f</p> <p>N001</p> <p>N005</p> <p>--</p> <p>N021</p> <p>N017</p>	<p>CODE</p>	 <p>64 mm</p>	<p>COLOR</p> <p>h f</p> <p>P009</p> <p>P013</p> <p>--</p> <p>P029</p> <p>P025</p>	<p>CODE</p>	 <p>64 mm</p>	<p>COLOR</p> <p>h f</p> <p>Y009</p> <p>Y013</p> <p>--</p> <p>Y029</p> <p>Y025</p>	<p>CODE</p>
 <p>48 mm</p>	<p>COLOR</p> <p>h f</p> <p>V001</p> <p>V005</p> <p>--</p> <p>V021</p> <p>V017</p>	<p>CODE</p>	<p>COLOR</p> <p>h f</p> <p> </p> <p> </p> <p> </p> <p> </p>	<p>CODE</p>	<p>COLOR</p> <p>h f</p> <p> </p> <p> </p> <p> </p> <p> </p>	<p>CODE</p>					

h=handle; f=frontplate
h=manopola; f=mostrina
Frontplate dimension on page 37/38
Dimensioni frontali a pag. 37/38

Metodo di ordinazione commutatori R20

In questo Catalogo si possono trovare alcuni schemi e le istruzioni per comporre autonomamente i codici d'ordinazione dei commutatori Serie R20 standard.

Per schemi Speciali o schemi non presenti in questo catalogo utilizzare il form. a pag. 34.

Gli schemi del presente catalogo ed il loro utilizzo nei codici sono applicabili esclusivamente alle serie di commutatori R20 e non per le altre Serie.

Codice prodotto

Esempio commutatore a manopola	R101	202002			-	W001
Esempio commutatore con chiave	R102	202002	07	D	-	K001
	①	②	③	④		⑤

① Modello del Commutatore.

Come n° di Modello si intende il montaggio e la forma costruttiva univoca di ogni commutatore
questo riferimento identifica la specifica costruzione meccanica del commutatore .

Questo n° di Modello viene indicato nel catalogo insieme al relativo disegno di ingombro e della foratura del pannello.

② Schema elettrico.

Questo numero rappresenta l'indicazione dello schema del commutatore richiesto.

Esso comprende lo schema elettrico ed il movimento della manopola , in riferimento agli schemi di seguito rappresentati.

③ Programma Bloccaggio/Estrazione chiave o altro.

Questo numero viene utilizzato solamente nei commutatori con chiave di comando , serratura di blocco, commutatore lucchettabile e commutatori con manopola estraibile.

Esso rappresenta la posizione in cui il commutatore può essere bloccato.

Il bloccaggio dei commutatori con chiave di comando o serratura di blocco avviene mediante l'estrazione della chiave dallo stesso.

Nei modelli con manopola estraibile la posizione il bloccaggio è la medesima di quelli a chiave , nei modelli lucchettabili il riferimento è invece la posizione dove viene data la possibilità di inserire il lucchetto.

La tabella di riferimento per il N° di programma di bloccaggio è presente a pag. 34 del presente catalogo e deve essere conforme allo spostamento della manopola previsto nello schema di riferimento del commutatore.

④ Chiave uguali tra di loro o chiavi differenti tra di loro.

Questo numero viene utilizzato solamente nei commutatori con chiave di comando , serratura di blocco.

Esso rappresenta se le chiavi dei commutatori devono essere uguali tra loro o Differenti tra loro.

La lettera "D" è l'indicazione di chiavi diverse tra di loro , quindi ogni commutatore ordinato avrà una chiave unica , quindi non è possibile manovrare altri commutatori con la medesima chiave.

Se non indicata i commutatori vengono forniti tutti con medesima chiave .

⑤ Tipo dimensione e colore Finitura (parte frontale)

Questo numero indica il tipo la dimensione ed il colore delle manopole e Finiture frontali del commutatore

Switch Function and Configuration

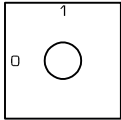
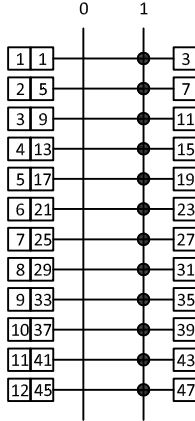
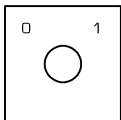
Function	Handle Movements	Decks	Code	Connection Diagram
On/Off Switches				
1 pole 2 pole 3 pole 4 pole 5 pole 6 pole 7 pole 8 pole 9 pole 10 pole 11 pole 12 pole		1 2 3 4 5 6 7 8 9 10 11 12	201019 202019 203019 204019 205019 206019 207019 208019 209019 210019 211019 212019	
1 pole 2 pole 3 pole 4 pole 5 pole 6 pole 7 pole 8 pole 9 pole 10 pole 11 pole 12 pole		1 2 3 4 5 6 7 8 9 10 11 12	201020 202020 203020 204020 205020 206020 207020 208020 209020 210020 211020 212020	

Double Throw Switch Without "0" position.

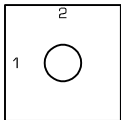
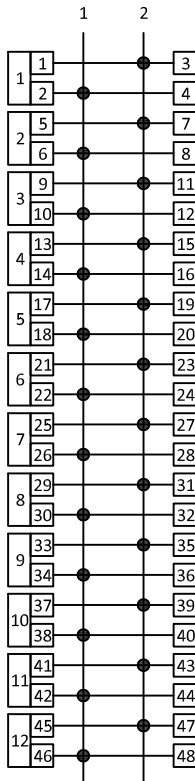
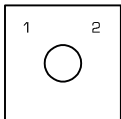
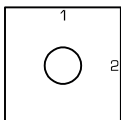
1 pole 2 pole 3 pole 4 pole 5 pole 6 pole 7 pole 8 pole 9 pole 10 pole 11 pole 12 pole		1 2 3 4 5 6 7 8 9 10 11 12	201001 202001 203001 204001 205001 206001 207001 208001 209001 210001 211001 212001	
1 pole 2 pole 3 pole 4 pole 5 pole 6 pole 7 pole 8 pole 9 pole 10 pole 11 pole 12 pole		1 2 3 4 5 6 7 8 9 10 11 12	201002 202002 203002 204002 205002 206002 207002 208002 209002 210002 211002 212002	
1 pole 2 pole 3 pole 4 pole 5 pole 6 pole 7 pole 8 pole 9 pole 10 pole 11 pole 12 pole		1 2 3 4 5 6 7 8 9 10 11 12	201003 202003 203003 204003 205003 206003 207003 208003 209003 210003 211003 212003	

Switch Function and Configuration

Function	Handle Movements	Decks	Code	Connection Diagram
----------	------------------	-------	------	--------------------

2 Positions switch with 1 input & 2 Output in each deck

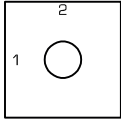
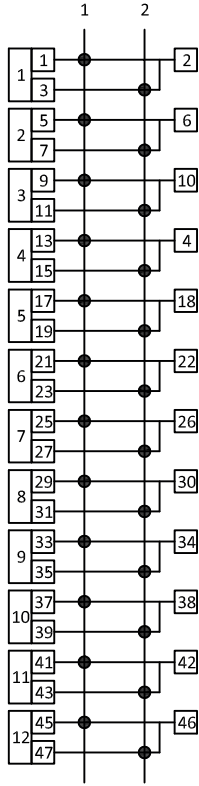
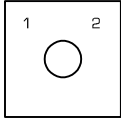
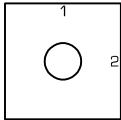
1 pole 2 pole 3 pole 4 pole 5 pole 6 pole 7 pole 8 pole 9 pole 10 pole 11 pole 12 pole		1 2 3 4 5 6 7 8 9 10 11 12	201007 202007 203007 204007 205007 206007 207007 208007 209007 210007 211007 212007	
1 pole 2 pole 3 pole 4 pole 5 pole 6 pole 7 pole 8 pole 9 pole 10 pole 11 pole 12 pole		1 2 3 4 5 6 7 8 9 10 11 12	201008 202008 203008 204008 205008 206008 207008 208008 209008 210008 211008 212008	
1 pole 2 pole 3 pole 4 pole 5 pole 6 pole 7 pole 8 pole 9 pole 10 pole 11 pole 12 pole		1 2 3 4 5 6 7 8 9 10 11 12	201009 202009 203009 204009 205009 206009 207009 208009 209009 210009 211009 212009	

2 Positions switch with Make before Break Contacts

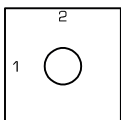
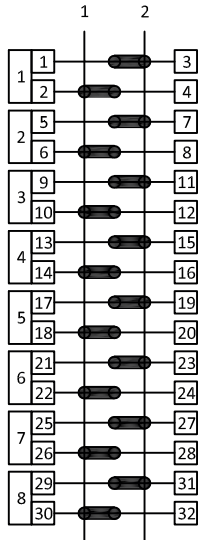
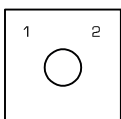
1 pole 2 pole 3 pole 4 pole 5 pole 6 pole 7 pole 8 pole		1 2 3 4 5 6 7 8	201055 202055 203055 204055 205055 206055 207055 208055	
1 pole 2 pole 3 pole 4 pole 5 pole 6 pole 7 pole 8 pole		1 2 3 4 5 6 7 8	201056 202056 203056 204056 205056 206056 207056 208056	

Switch Function and Configuration

Function	Handle Movements	Decks	Code	Connection Diagram
----------	------------------	-------	------	--------------------

3 pos. switch with "0" Position with electrically isolated contacts

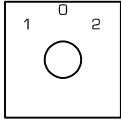
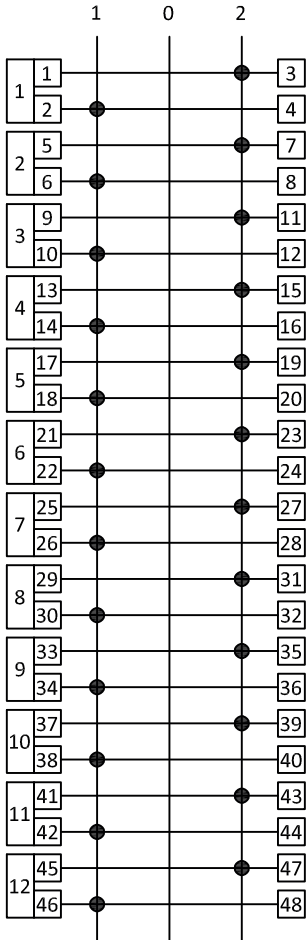
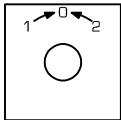
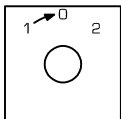
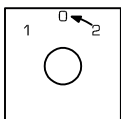
1 pole 2 pole 3 pole 4 pole 5 pole 6 pole 7 pole 8 pole 9 pole 10 pole 11 pole 12 pole		1 2 3 4 5 6 7 8 9 10 11 12	301001 302001 303001 304001 305001 306001 307001 308001 309001 310001 311001 312001	
With Spring return to "0" position from pos."1" & pos."2". 1 pole 2 pole 3 pole 4 pole 5 pole 6 pole 7 pole 8 pole		1 2 3 4 5 6 7 8	M301001 M302001 M303001 M304001 M305001 M306001 M307001 M308001	
With Spring return to "0" position from pos."1". 1 pole 2 pole 3 pole 4 pole 5 pole 6 pole 7 pole 8 pole		1 2 3 4 5 6 7 8	301012 302012 303012 304012 305012 306012 307012 308012	
With Spring return to "0" position from pos."2". 1 pole 2 pole 3 pole 4 pole 5 pole 6 pole 7 pole 8 pole		1 2 3 4 5 6 7 8	301020 302020 303020 304020 305020 306020 307020 308020	

Switch Function and Configuration

Function	Handle Movements	Decks	Code	Connection Diagram
----------	------------------	-------	------	--------------------

3 pos. switch with "0" Position with 1 input and 2 output in each deck.

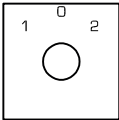
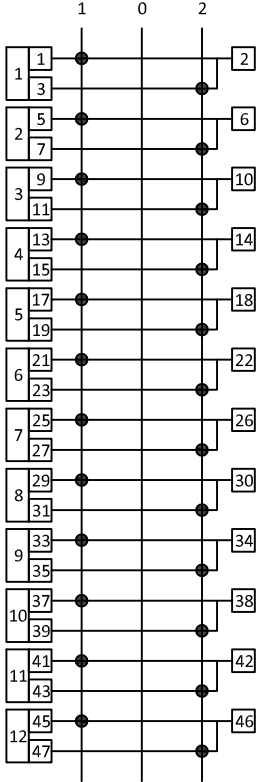
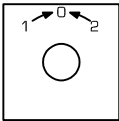
1 pole 2 pole 3 pole 4 pole 5 pole 6 pole 7 pole 8 pole 9 pole 10 pole 11 pole 12 pole		1 2 3 4 5 6 7 8 9 10 11 12	301003 302003 303003 304003 305003 306003 307003 308003 309003 310003 311003 312003	
With Spring return to "0" position from pos."1" & pos."2". 1 pole 2 pole 3 pole 4 pole 5 pole 6 pole 7 pole 8 pole		1 2 3 4 5 6 7 8	M301003 M302003 M303003 M304003 M305003 M306003 M307003 M308003	

3 pos. switch without "0" Position with 1 input and 3 output in each deck.

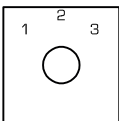
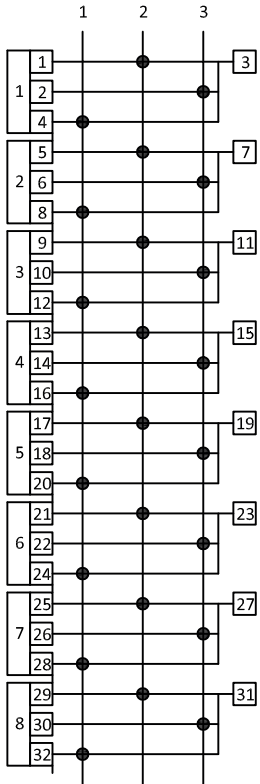
1 pole 2 pole 3 pole 4 pole 5 pole 6 pole 7 pole 8 pole 9 pole 10 pole 11 pole 12 pole		1 2 3 4 5 6 7 8 9 10 11 12	301004 302004 303004 304004 305004 306004 307004 308004 309004 310004 311004 312004	
---	---	---	--	---

Switch Function and Configuration

Function	Handle Movements	Decks	Code	Connection Diagram
----------	------------------	-------	------	--------------------

3 pos. switch Without "0" Position, with electrically isolated contacts.

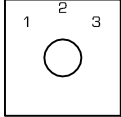
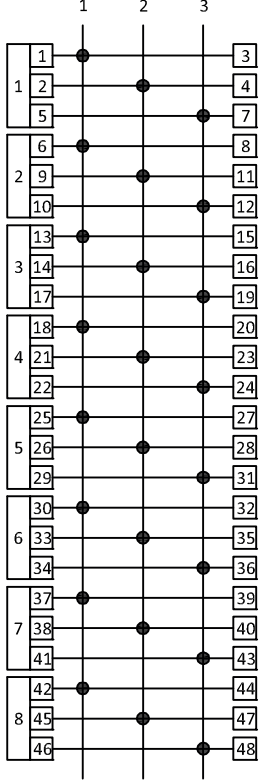
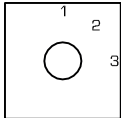
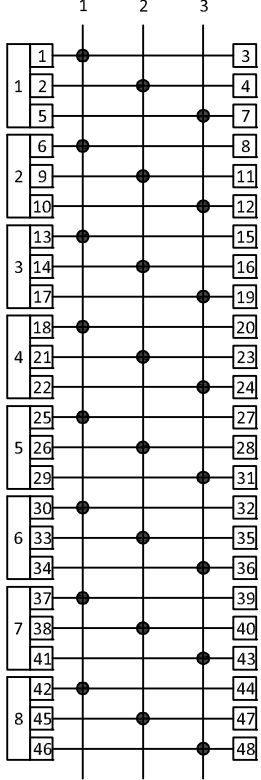
1 pole 2 pole 3 pole 4 pole 5 pole 6 pole 7 pole 8 pole		2 3 5 6 8 9 11 12	302078 303078 305078 306078 308078 309078 311078 312078	
1 pole 2 pole 3 pole 4 pole 5 pole 6 pole 7 pole 8 pole		2 3 5 6 8 9 11 12	302134 303134 305134 306134 308134 309134 311134 312134	

3 pos. switch with "0" Position, with electrically isolated contacts.

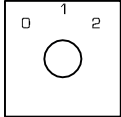
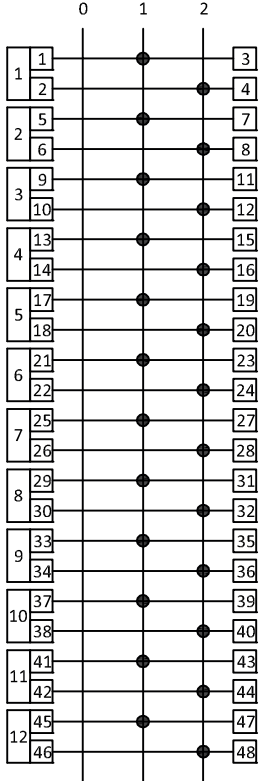
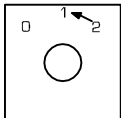
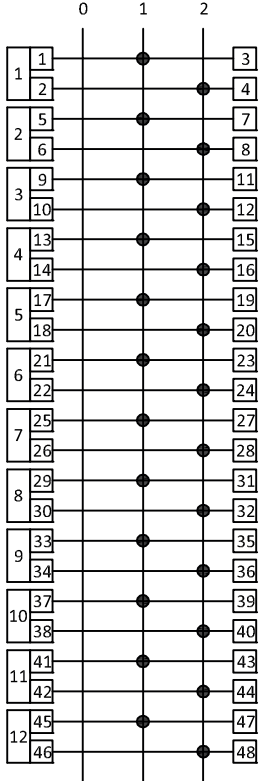
1 pole 2 pole 3 pole 4 pole 5 pole 6 pole 7 pole 8 pole 9 pole 10 pole 11 pole 12 pole		1 2 3 4 5 6 7 8 9 10 11 12	301016 302016 303016 304016 305016 306016 307016 308016 309016 310016 311016 312016	
With Spring return to "0" position from pos."2". 1 pole 2 pole 3 pole 4 pole 5 pole 6 pole 7 pole 8 pole		1 2 3 4 5 6 7 8	301048 302048 303048 304048 305048 306048 307048 308048	

Switch Function and Configuration

Function	Handle Movements	Decks	Code	Connection Diagram
----------	------------------	-------	------	--------------------

4 pos. switch With "0" Position, with electrically isolated contacts.

1 pole 2 pole 3 pole 4 pole 5 pole 6 pole		2 4 6 8 10 12	402008 404008 406008 408008 410008 412008	
1 pole 2 pole 3 pole 4 pole 5 pole 6 pole		2 4 6 8 10 12	402087 404087 406087 408087 410087 412087	

4 pos. switch with "0" Position, with 1 Input and 3 output per Pole.

1 pole 2 pole 3 pole 4 pole 5 pole 6 pole		2 4 6 8 10 12	402011 404011 406011 408011 410011 412011	
1 pole 2 pole 3 pole 4 pole 5 pole 6 pole		2 4 6 8 10 12	402088 404088 406088 408088 410088 412088	

Switch Function and Configuration

Function	Handle Movements	Decks	Code	Connection Diagram
----------	------------------	-------	------	--------------------

4 pos. switch Without "0" Position, with electrically isolated contacts.

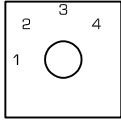
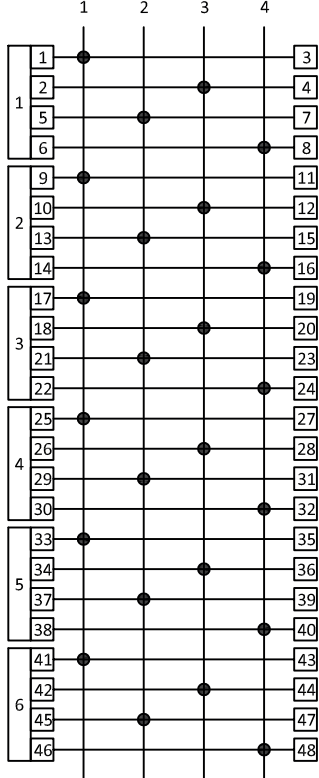
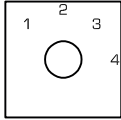
1 pole 2 pole 3 pole 4 pole 5 pole 6 pole		2 4 6 8 10 12	402003 404003 406003 408003 410003 412003	
1 pole 2 pole 3 pole 4 pole 5 pole 6 pole		2 4 6 8 10 12	402017 404017 406017 408017 410017 412017	

4 pos. switch without "0" Position, with 1 Input and 4 output per Pole.

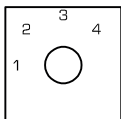
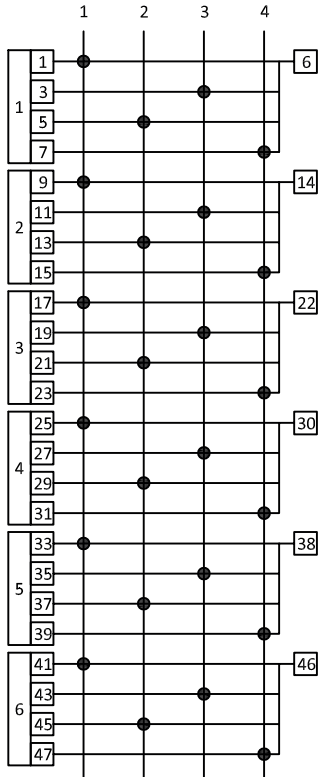
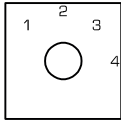
1 pole 2 pole 3 pole 4 pole 5 pole 6 pole		2 4 6 8 10 12	402007 404007 406007 408007 410007 412007	
1 pole 2 pole 3 pole 4 pole 5 pole 6 pole		2 4 6 8 10 12	402089 404089 406089 408089 410089 412089	

Switch Function and Configuration

Function	Handle Movements	Decks	Code	Connection Diagram
----------	------------------	-------	------	--------------------

5 pos. switch With "0" Position, with electrically isolated contacts.

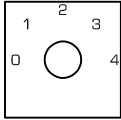
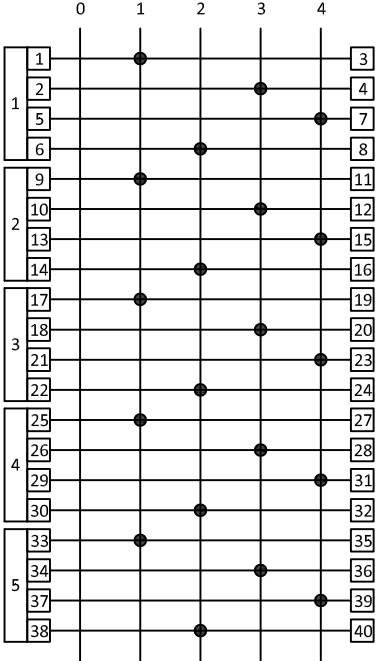
1 pole 2 pole 3 pole 4 pole 5 pole		2 4 6 8 10	502020 504020 506020 508020 510020	
--	---	------------------------	--	---

5 pos. switch with "0" Position, with 1 Input and 4 output per Pole.

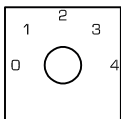
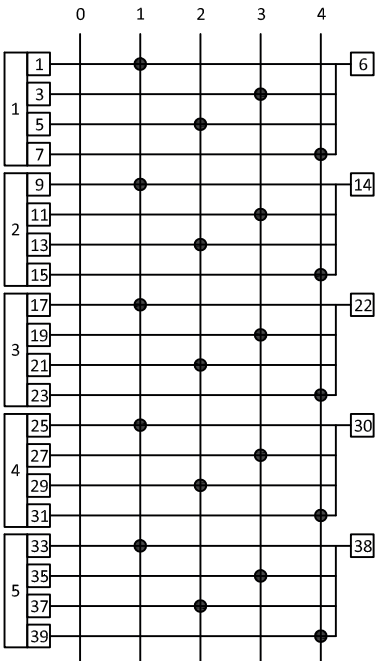
1 pole 2 pole 3 pole 4 pole 5 pole		2 4 6 8 10	502010 504010 506010 508010 510010	
--	---	------------------------	--	--

Switch Function and Configuration

Function	Handle Movements	Decks	Code	Connection Diagram
----------	------------------	-------	------	--------------------

5 pos. switch Without "0" Position, with electrically isolated contacts.

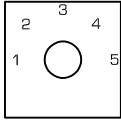
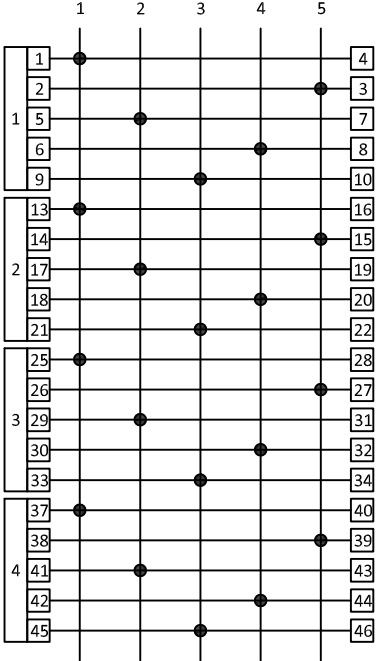
1 pole 2 pole 3 pole 4 pole		3 6 9 12	503018 506018 509018 512018	
--------------------------------------	---	-------------------	--------------------------------------	---

5 pos. switch without "0" Position, with 1 Input and 5 output per Pole.

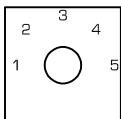
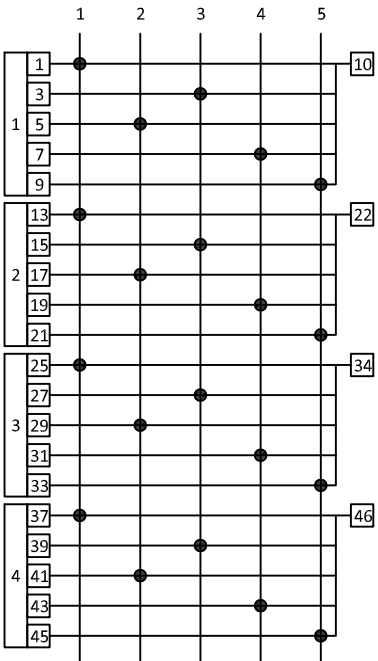
1 pole 2 pole 3 pole 4 pole		3 6 9 12	503013 506013 509013 512013	
--------------------------------------	---	-------------------	--------------------------------------	--

Switch Function and Configuration

Function	Handle Movements	Decks	Code	Connection Diagram
----------	------------------	-------	------	--------------------

6 pos. switch With "0" Position, with electrically isolated contacts.

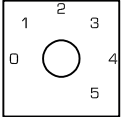
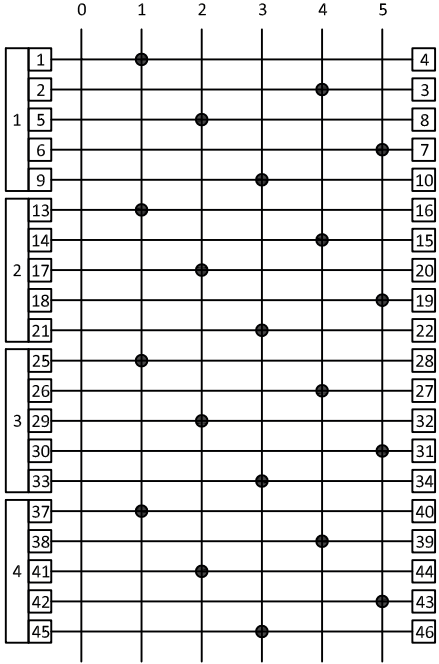
<p>1 pole 2 pole 3 pole 4 pole</p>		<p>3 6 9 12</p>	<p>603009 606009 609009 612009</p>	
--	---	-----------------------------	--	---

6 pos. switch with "0" Position, with 1 Input and 5 output per Pole.

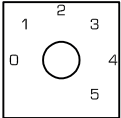
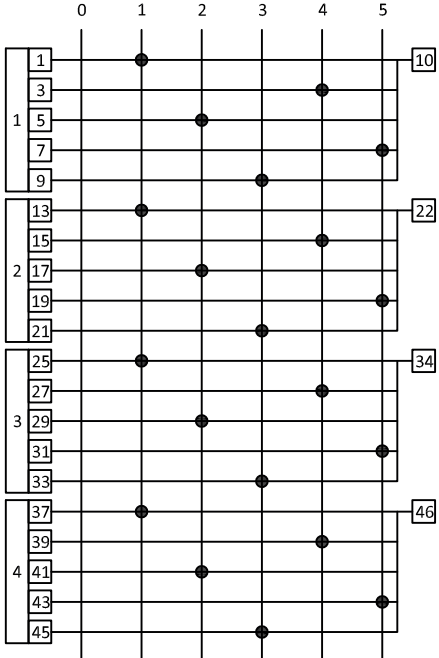
<p>1 pole 2 pole 3 pole 4 pole</p>		<p>3 6 9 12</p>	<p>603003 606003 609003 612003</p>	
--	---	-----------------------------	--	--

Switch Function and Configuration

Function	Handle Movements	Decks	Code	Connection Diagram
----------	------------------	-------	------	--------------------

6 pos. switch Without "0" Position, with electrically isolated contacts.

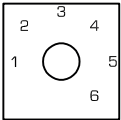
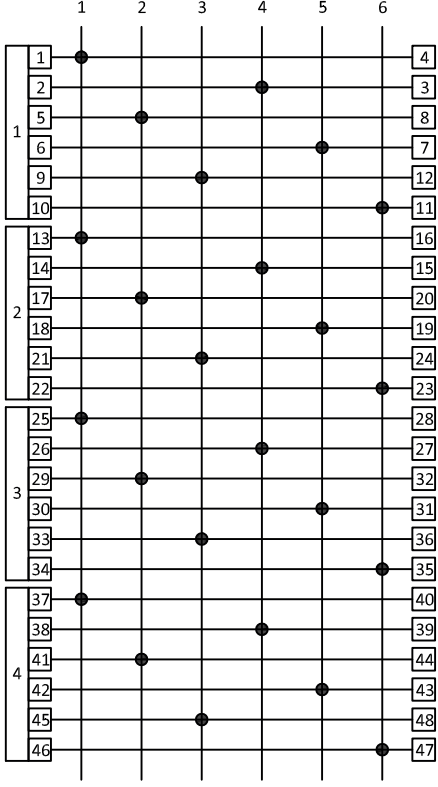
1 pole 2 pole 3 pole 4 pole		3 6 9 12	603008 606008 609008 612008	
--------------------------------------	---	-------------------	--------------------------------------	---

6 pos. switch without "0" Position, with 1 Input and 6 output per Pole.

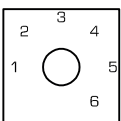
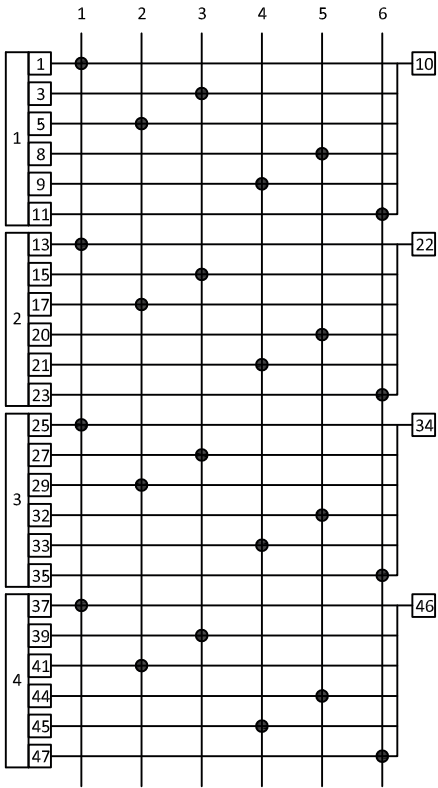
1 pole 2 pole 3 pole 4 pole		3 6 9 12	603004 606004 609004 612004	
--------------------------------------	---	-------------------	--------------------------------------	--

Switch Function and Configuration

Function	Handle Movements	Decks	Code	Connection Diagram
----------	------------------	-------	------	--------------------

7 pos. switch With "0" Position, with electrically isolated contacts.

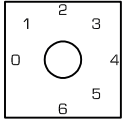
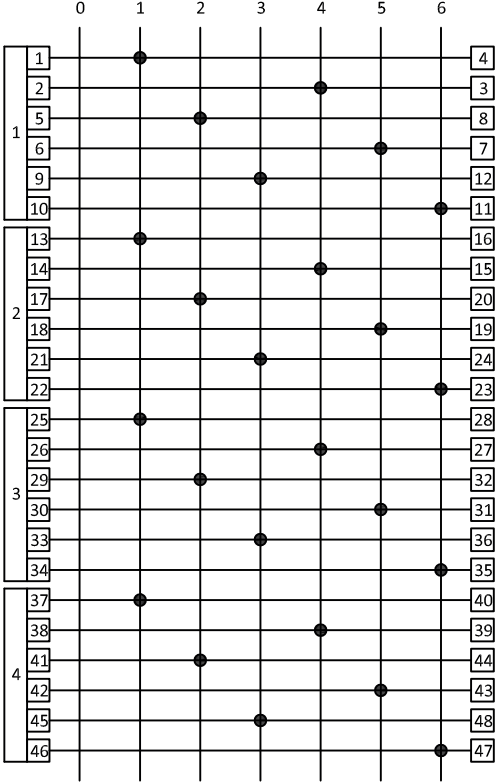
1 pole 2 pole 3 pole 4 pole		3 6 9 12	703012 706012 709012 712012	
--------------------------------------	---	-------------------	--------------------------------------	---

7 pos. switch with "0" Position, with 1 Input and 6 output per Pole.

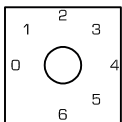
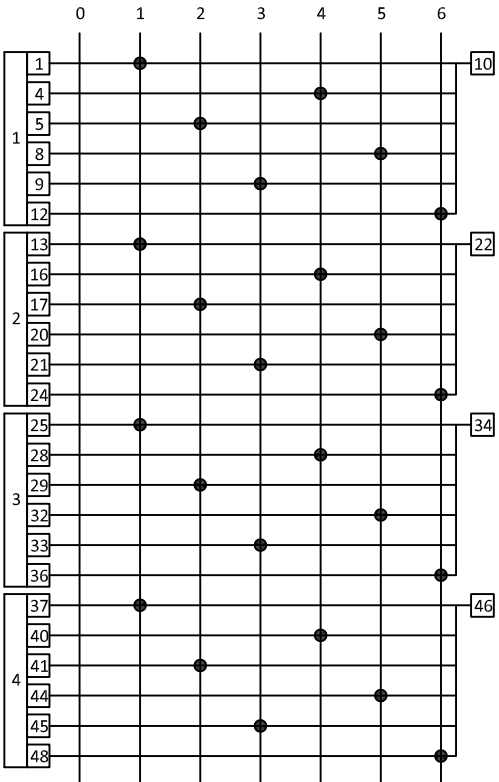
1 pole 2 pole 3 pole 4 pole		3 6 9 12	703006 706006 709006 712006	
--------------------------------------	---	-------------------	--------------------------------------	--

Switch Function and Configuration

Function	Handle Movements	Decks	Code	Connection Diagram
----------	------------------	-------	------	--------------------

7 pos. switch Without "0" Position, with electrically isolated contacts.

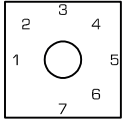
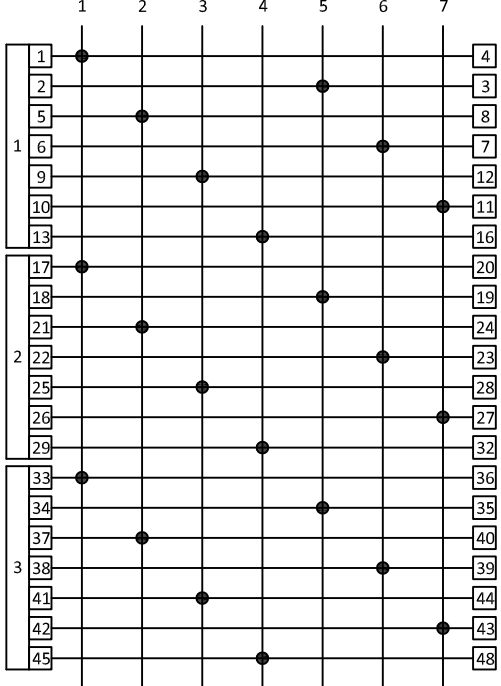
1 pole 2 pole 3 pole		4 8 12	704001 708001 712001	
----------------------------	---	--------------	----------------------------	---

7 pos. switch Without "0" Position, with 1 Input and 7 output per Pole.

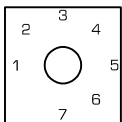
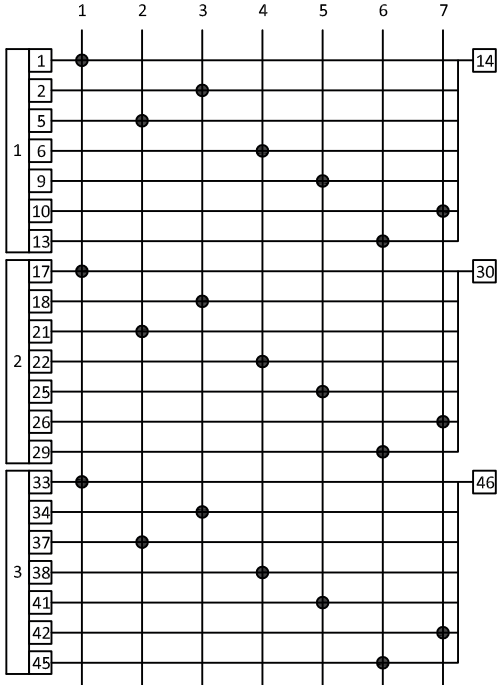
1 pole 2 pole 3 pole		4 8 12	704013 708013 712013	
----------------------------	---	--------------	----------------------------	--

Switch Function and Configuration

Function	Handle Movements	Decks	Code	Connection Diagram
----------	------------------	-------	------	--------------------

8 pos. switch With "0" Position, with electrically isolated contacts.

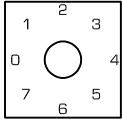
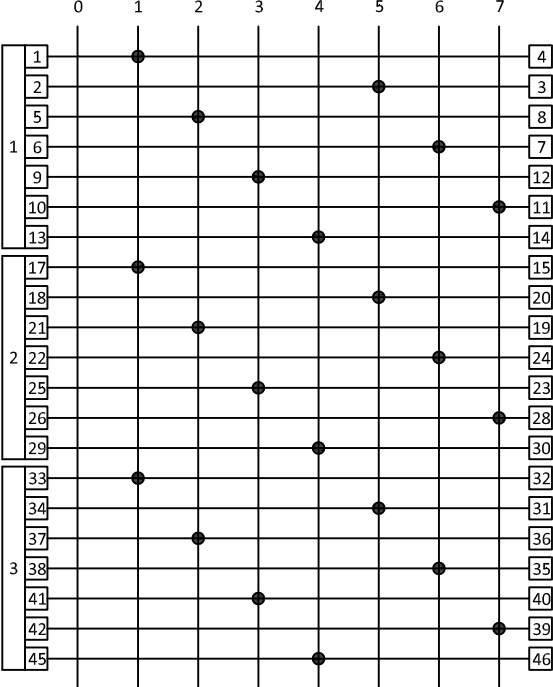
<p>1 pole 2 pole 3 pole</p>		<p>4 8 12</p>	<p>804003 808003 812003</p>	
-------------------------------------	---	-----------------------	-------------------------------------	---

8 pos. switch with "0" Position, with 1 Input and 7 output per Pole.

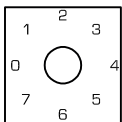
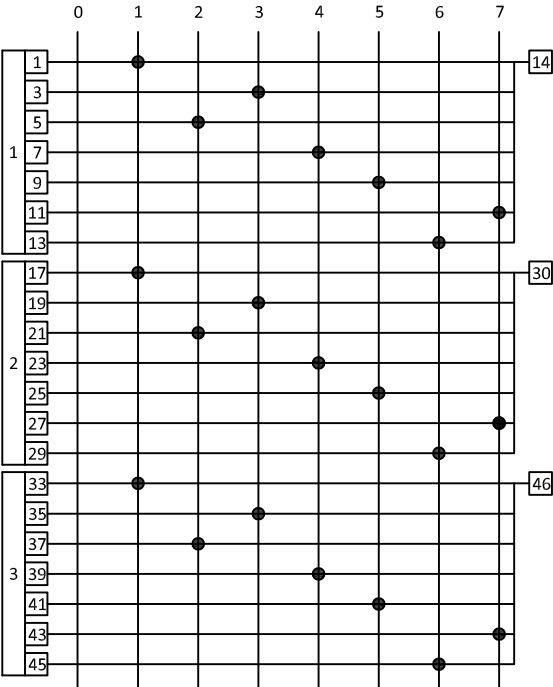
<p>1 pole 2 pole 3 pole</p>		<p>4 8 12</p>	<p>804005 808005 812005</p>	
-------------------------------------	---	-----------------------	-------------------------------------	--

Switch Function and Configuration

Function	Handle Movements	Decks	Code	Connection Diagram
----------	------------------	-------	------	--------------------

8 pos. switch Without "0" Position, with electrically isolated contacts.

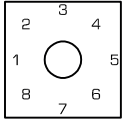
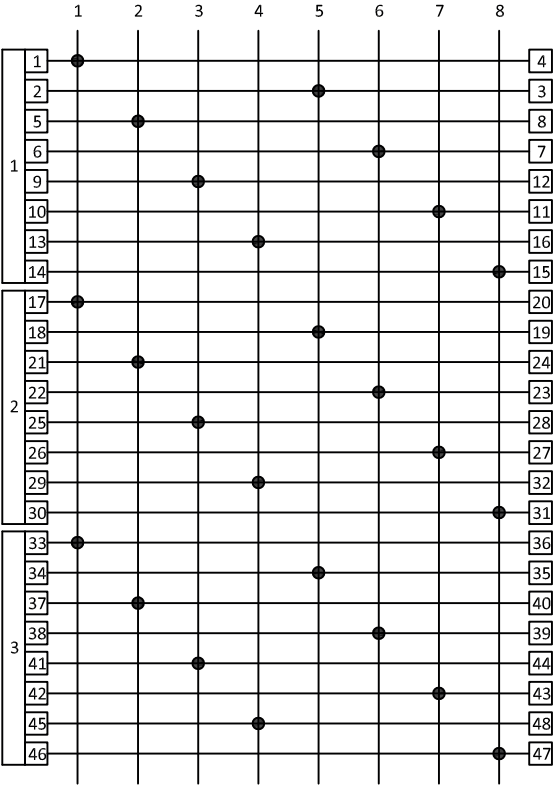
1 pole 2 pole 3 pole		4 8 12	804001 808001 812001	
----------------------------	---	--------------	----------------------------	---

8 pos. switch without "0" Position, with 1 Input and 8 output per Pole.

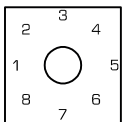
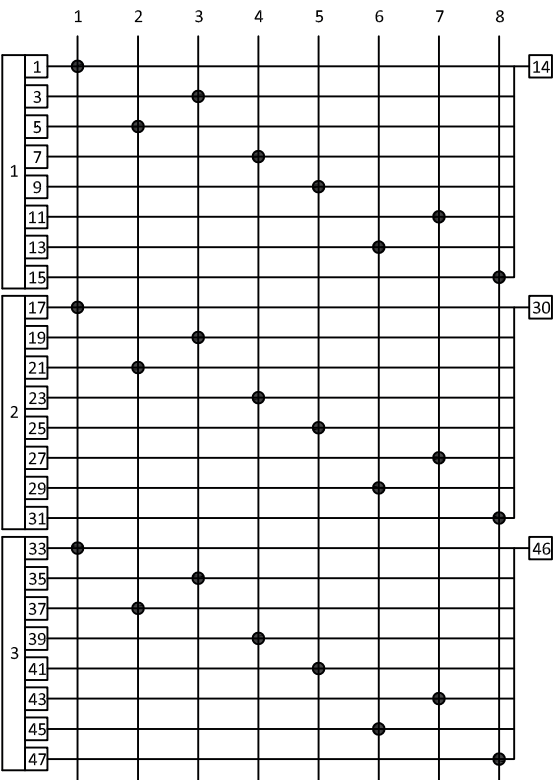
1 pole 2 pole 3 pole		4 8 12	804002 808002 812002	
----------------------------	---	--------------	----------------------------	--

Switch Function and Configuration

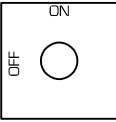
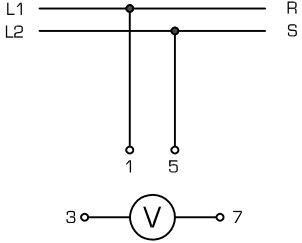
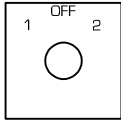
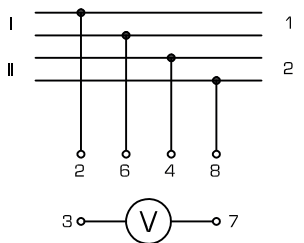
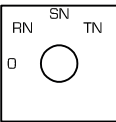
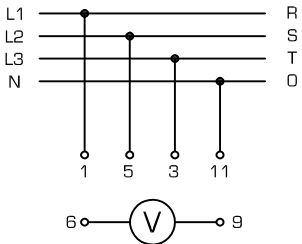
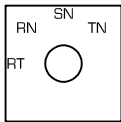
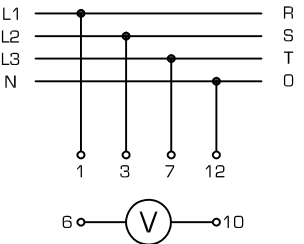
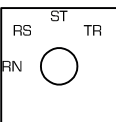
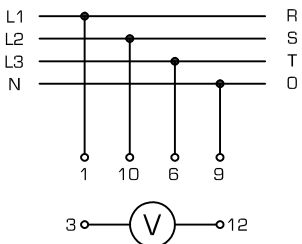
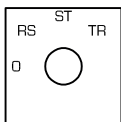
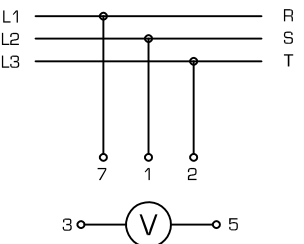
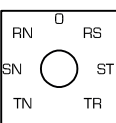
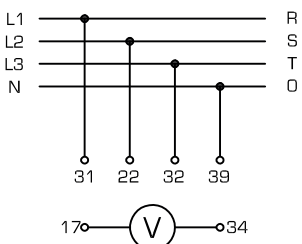
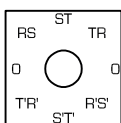
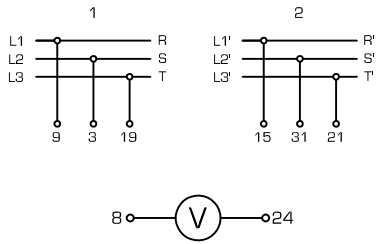
<p>Diagram n° 202V</p>	<p>VOLTMETER SWITCH: 2 wire Single Phase or DC</p>	<p>Diagram n° 302V10</p>	<p>VOLTMETER SWITCH: 4 wire two Phases or two separate DC circuits</p>
			
<p>Diagram n° 403V15</p>	<p>VOLTMETER SWITCH: 3 Phase Voltage</p>	<p>Diagram n° 403V16</p>	<p>VOLTMETER SWITCH: 1 Phase to Phase and 3 phases Voltage.</p>
			
<p>Diagram n° 403V17</p>	<p>VOLTMETER SWITCH: 1 Phase Voltage and 3 Phase to Phase</p>	<p>Diagram n° 402V09</p>	<p>VOLTMETER SWITCH: 3 Phase to Phase</p>
			
<p>Diagram n° 705V12</p>	<p>VOLTMETER SWITCH: 3 Phase and 3 Phase to Phase</p>	<p>Diagram n° 8S08</p>	<p>VOLTMETER SWITCH: 3 Phase to Phase in two 3 Phase circuits.</p>
			

Switch Function and Configuration

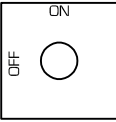
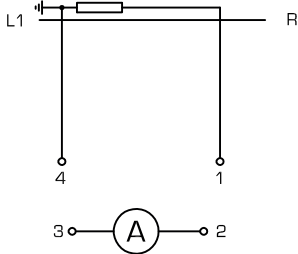
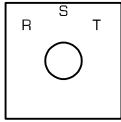
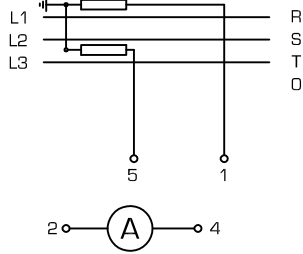
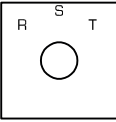
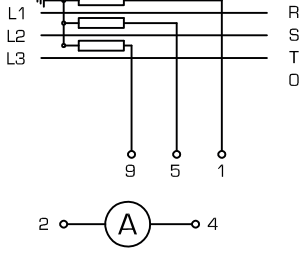
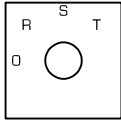
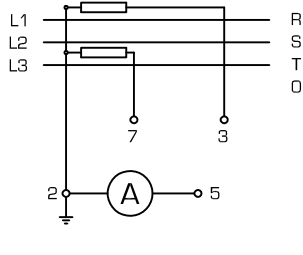
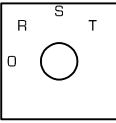
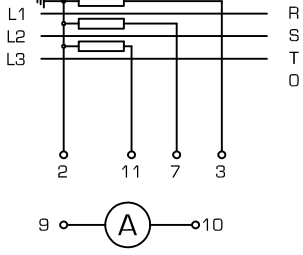
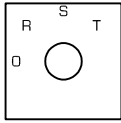
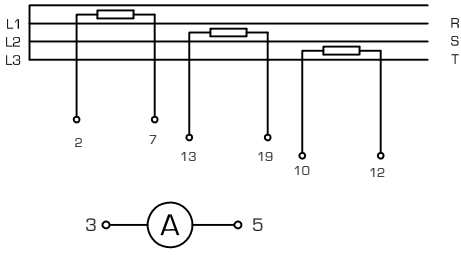
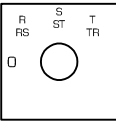
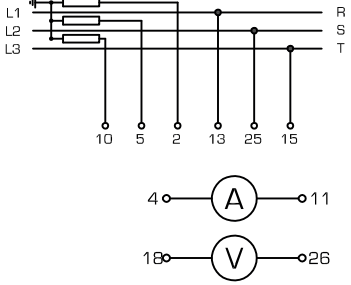
<p>Diagram n° 2G02</p>	<p>AMMETER SWITCH: 1 phase Current Transformer with "0" Pos.</p>	<p>Diagram n° 302A01</p>	<p>AMMETER SWITCH: 3 Current Measurements with 2 CT without "0"</p>
			
<p>Diagram n° 303A11</p>	<p>AMMETER SWITCH: 3 Current Measurements with 3 CT without "0"</p>	<p>Diagram n° 402A06</p>	<p>AMMETER SWITCH: 3 Current Measurements with 2 CT with "0"</p>
			
<p>Diagram n° 403A08</p>	<p>AMMETER SWITCH: 3 Current Measurements with 3 CT with "0"</p>	<p>Diagram n° 405A02</p>	<p>AMMETER SWITCH: 3 Current Measurements with 3 CT with "0" crossing Currents.</p>
			
<p>Diagram n° 407AV01</p>	<p>VOLT-AMMETER SWITCH: 3 Current Measurements with 3 CT with "0" For Voltages and Currents Measurements</p>		
			

Standard Escutcheon Plate Ordering

La mostrina si intende parte integrante del commutatore in quanto necessaria per il fissaggio al pannello dello stosso, se non specificata nessuna incisione essa verrà fornita Neutra, codice 00000.

The Escutcheon plate is strictly necessary for fitting the switch to the panel , if none engraving is specified , the frontplate will be supplied Blank , code 00000. The engraving listed below, are only a little part of those available, requir the code of the needed one if not present.

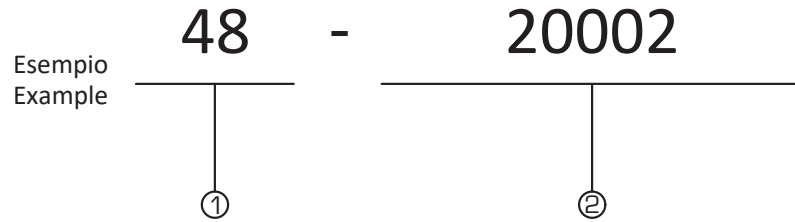

① Dimensions of the Escutcheon Plate.

48= 48x48mm
64= 64x64mm

②

2 Positions

1 O	AUT. MAN	MAN. AUT.	AUT. MAN.	1 2	INCL. ESQ.	DIST. LOC.	2 1	REMOTE LOCAL	1 E	L R	LOC. REM.	TE TI	OFF ON
20002	20004	20006	20007	20008	20010	20012	20013	20016	20022	20028	20030	20035	20036
R L	REM. LOC.	ON OFF	AUTO O	MAN. O	LOC. DIST.	OFF ON	AUT. MAN	PROVA SERVIZIO	LOC. SUPV.	EMERGENCY NORMAL	A B	SHIP SHORE	HAND AUTO
20037	20041	20050	20054	20055	20059	20068	20070	20106	20187	20160	20065	20085	20184
PARALLELE INDIVIDUAL	REM. SUPV.	MANUAL AUTO	IN OUT	TRIP ALARM	MANUAL AUTO	SERV. TRIP	NORMAL TEST	TR1 TR2	ATA ATB	MAN A B INVA	WINTER SUMMER	LOC. SCADA	OUTBOARD SHORE
20116	20404	20231	20322	20505	20463	20058	20138	20174	20196	20277	20289	20429	20341
NORMAL TRANSFER	REM. SUPV.	GS	BYPASS SERVICE	M	O	OUT IN	TRIP NORMAL	DG1 DG2	HAND AUTO	AUTO MANUAL			
20346	20404	20161	20510	20021	20001	20464	20553	20279	20152	20205			

3 Positions

MAN. AUT.	AUT. MAN.	M A	CH. AP.	DIM. ALUM.	AP. CH.	1 2	TEST TRIP	1 2	LOC. DIST.	1 2 3	ALUM. DIM.	OPEN CLOSE	CLOSE OPEN
30003	30004	30005	30010	30011	30012	30013	30014	30015	30016	30017	30019	30024	30031
A C B	START STOP	TRIP CLOSE	LOC. REM.	LOC. AUT.	2 1 3	O MAN. AUT.	O MAN. AUT.	O 1 2	C-BREAKER TRIP CLOSE	TEST STOP	EM. LOC. REM.	ON OFF TEST	RAISE LOWER
30032	30050	30052	30057	30060	30082	30083	30084	30385	30085	30086	30078	30079	30087
DCS SCADA SCS	INCR. DECR.	COLD HEAT	G1 G2	A B	OFF ON	L R	O 1+3	NEUTRAL CLOSE	1 OFF 2	RS ST TR	RY YB BR	R S T	R Y B
30088	30089	30090	30040	30047	30055	30062	30172	30120	30561	30630	30631	30632	30633
TEST LOC. REM.	A B C	TEST TRIP N.O.	AUTO OFF MAN.	LOWER OFF RAISE	OUVRE FERME	LOC. REM. SUPV.	SHORE OFF GEN.	IN OUT	AUTO HAND	LOC. OFF REM.	TR1 PARALL. TR2	T1 T2	MAN. LOC. REM.
30025	30114	30371	30080	30113	30154	30165	30634	30626	30635	30467	30476	30486	30192
IN NORMAL OUT	BYPASS OFF CHECK	O L1 L2	S P M	AUTO MAN.									
30609	30608	30183	30526	30108									

4 Positions

 40001	 40002	 40003	 40004	 40005	 40006	 40007	 40008	 40009	 40010	 40011	 40012	 40013	 40014
 40112	 40027	 40017	 40015	 40018	 40019	 40021	 40022	 30015	 40177	 40023	 40072	 40029	 40071
 40235	 40019	 40230	 40237	 40037	 40056	 40137	 40223	 40231					

5 Positions

 50001	 50002	 50005	 50006	 50048	 50005	 50061	 50051	 50062	 50063	 50014	 50010	 50064
-----------	-----------	-----------	-----------	-----------	-----------	-----------	-----------	-----------	-----------	-----------	-----------	-----------

6 Positions

 60001	 60002	 60015	 60019	 60016	 60020
-----------	-----------	-----------	-----------	-----------	-----------

7 Positions

 70001	 70002	 70007
-----------	-----------	-----------

8 Positions

 80004	 80005	 80003	 80001	 80002	 80006	 80007	 80008	 80023
-----------	-----------	-----------	-----------	-----------	-----------	-----------	-----------	-----------

Blank

 00000

Locking Programs

La linea di riferimento indica la posizione in cui il commutatore è bloccato e la chiave è estratta.
The reference line shows where the switch is blocked and the key is withdrawn.

 01	 02	 03	 04	 05	 06	 07	 08	 09	 10	 11	 12	 13	 14	 15	 16	 17	 18	 19
 27	 28																	

Form for special diagram

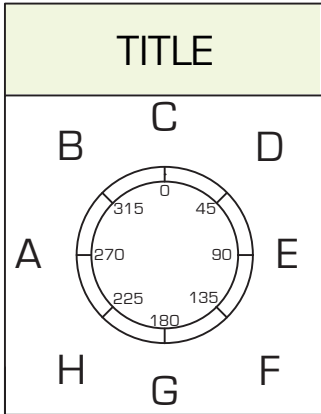

Position Engraving	
Position	Engraving
TITLE	
A	
B	
C	
D	
E	
F	
G	
H	

Lock in Pos.	<input type="checkbox"/>	<input type="checkbox"/>	<input type="checkbox"/>	<input type="checkbox"/>	<input type="checkbox"/>	<input type="checkbox"/>	<input type="checkbox"/>	<input type="checkbox"/>	<input type="checkbox"/>
Spring Return	<input type="checkbox"/>	<input type="checkbox"/>	<input type="checkbox"/>	<input type="checkbox"/>	<input type="checkbox"/>	<input type="checkbox"/>	<input type="checkbox"/>	<input type="checkbox"/>	<input type="checkbox"/>
Positions									
A	B	C	D	E	F	G	H		

Contacts	
1	
2	
3	
4	
5	
6	
7	
8	
9	
10	
11	
12	
13	
14	
15	
16	
17	
18	
19	
20	
21	
22	
23	
24	

Switch Action :

Stayput Spring return Stayput and Spring return

Specification:.....

Model number:

Ordering Code : (it will provided by COMELETRIC)

Accessories / Informations:

Panel Mounting <input type="checkbox"/>	Pistol Grip Handle <input type="checkbox"/>	Key Lock (Different Keys) <input type="checkbox"/>
Base Mounting <input type="checkbox"/>	Padlockable <input type="checkbox"/>	Electromechanical interlock <input type="checkbox"/>
Gilded Contacts <input type="checkbox"/>	Mechanical Indicator (only for Spring Return Switches) <input type="checkbox"/>	Led Indicator <input type="checkbox"/>
IP55 Front Protection <input type="checkbox"/>	Key Lock (Same Keys) <input type="checkbox"/>	Removable Knob <input type="checkbox"/>
Push to Operate <input type="checkbox"/>	Pull to Operate <input type="checkbox"/>	Master Key <input type="checkbox"/>

Legenda Symbols

	Closed Contact		Spring Return
	Closed Contact Two consecutive Positions		Spring Return from Left and Right
	Make Before Break Contacts		
	Dragged Contact		

BR001 Models:

Designed for the Circuit Breaker control. It consists of two main groups of contacts and a dragging joint. The group dragged contacts is used as an alarm or indication.

Progettato per il comando interruttore. Esso è formato da due gruppi di contatti uno principale ed uno trascinato. Il gruppo contatti trascinato viene utilizzato come allarme o indicazione.

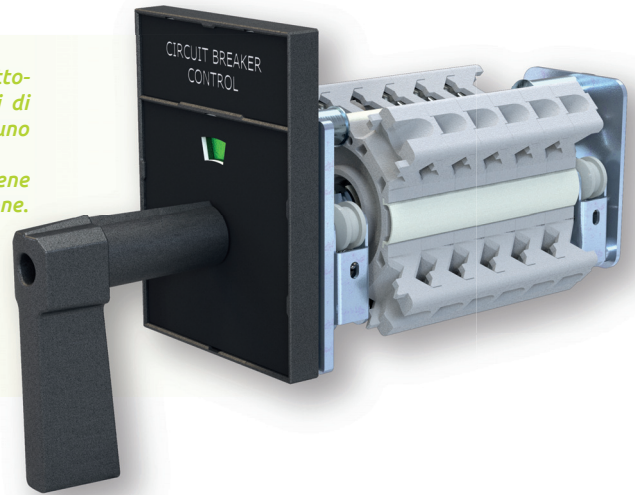

Dimensions

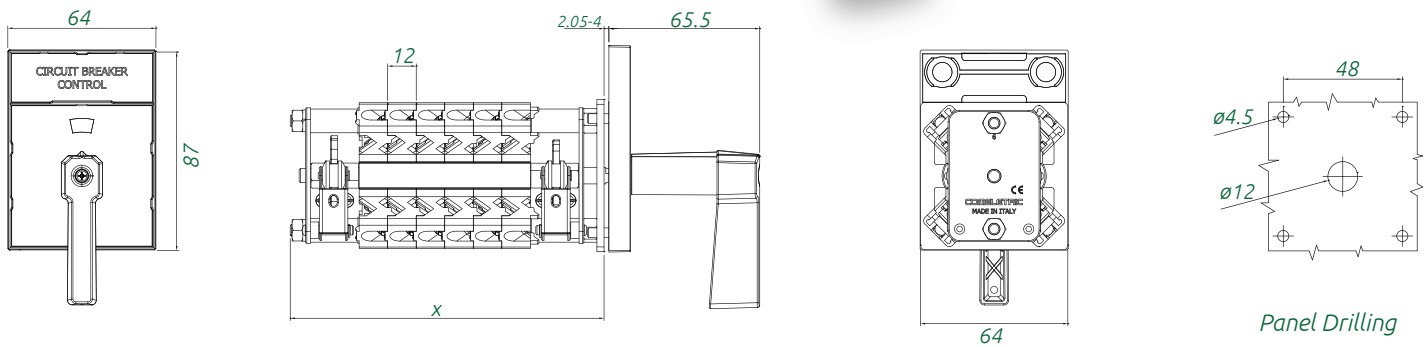

N° of packets	2	3	4	5	6	7	8	9	10	11	12
Length (mm)	110	122	134	146	158	170	182	194	206	218	230

BR001 Frontplates BR001 Mostrine

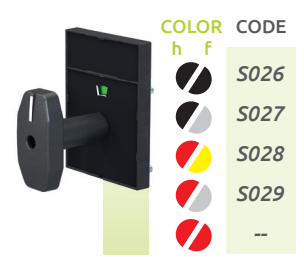
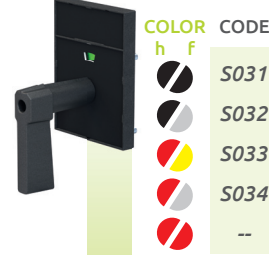
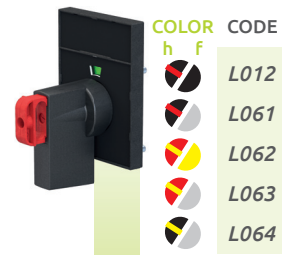
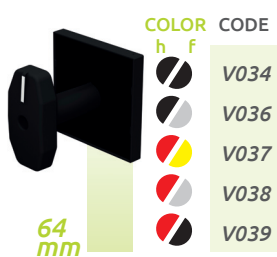
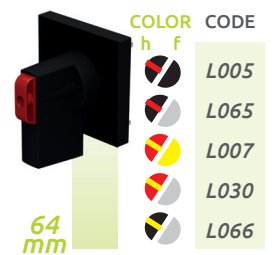
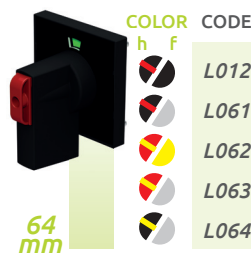
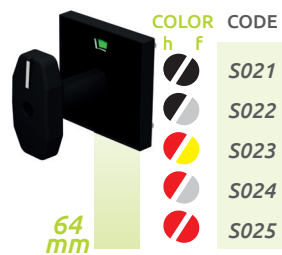

h=handle; f=frontplate
h=manopola; f=mostrina
Frontplate dimension on page 37/38
Dimensioni frontali a pag. 37/38

Switches with Dragging contacts Function and Configuration

N.A. = Normal After

Handle Movements	Code	Connection Diagram	Handle Movements	Code	Connection Diagram
	301+1001			302+1002	
	302+2002			402+2001	
	402+2012			402+1006	
	403+2004			402+3003	

Wing Handle 48x48
Manopola Wing 48x48

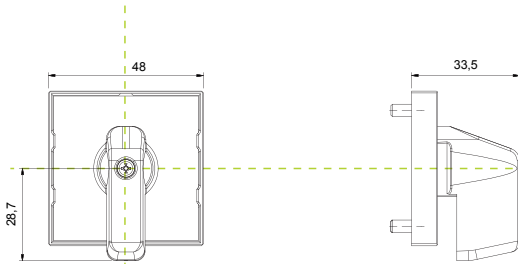

Wing Handle 64x64
Manopola Wing 64x64

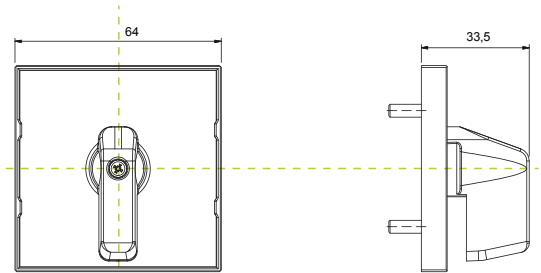

Pistol Grip Handle 48x48
Manopola Pistola 48x48

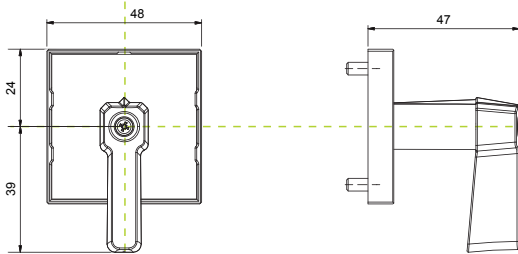

Big Pistol Grip Handle 64x64 (Trip Indicator)
Manopola Pistola Grande 64x64

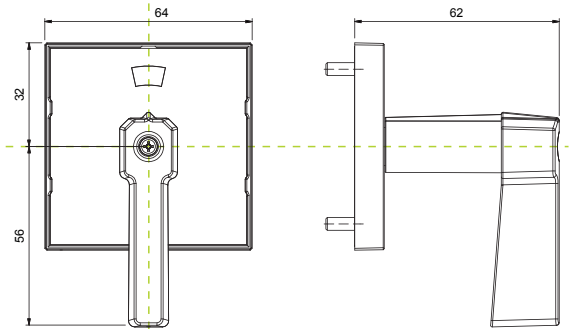

Key Operated 48x48
Operatore a Chiave 48x48

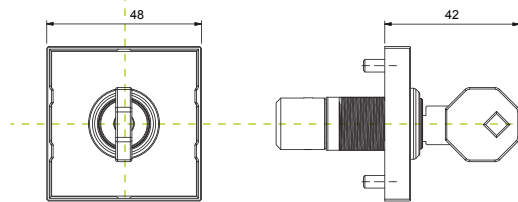

Padlockable 48x48
Manopola Lucchettabile 48x48

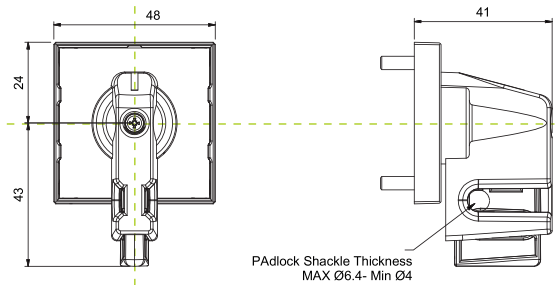

Small Padlockable 48x48
Lucchettabile Piccola 48x48

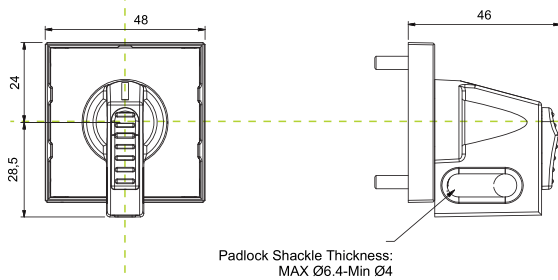

Big Oval Handle 64x64
Manopola Ovale Grande 64x64

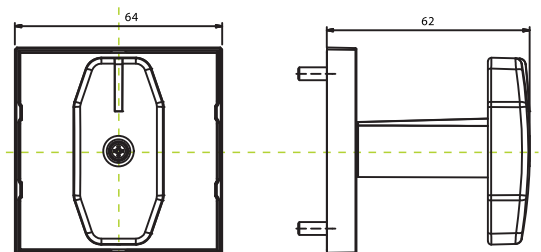

Big Pistol Grip Handle 48x48
Manopola a Pistola Grande 48x48

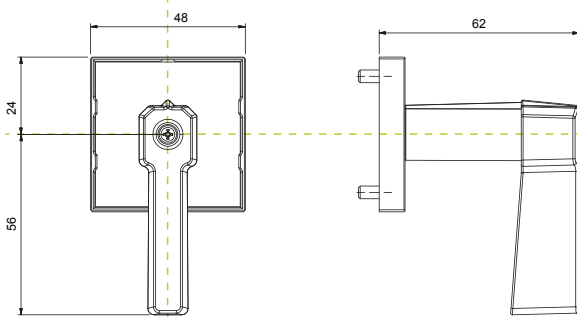

Big Padlockable Handle 64x64
Manopola Lucchettabile Grande 64x64

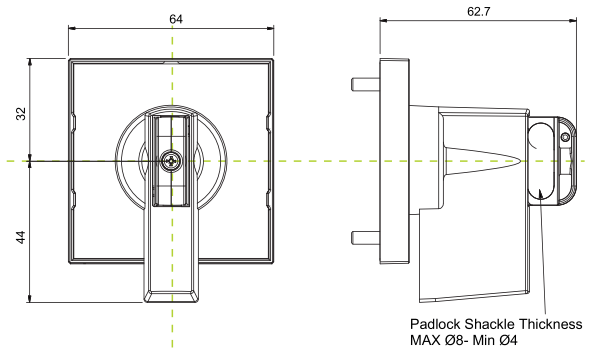

Key Operated 64x64
Operatore a Chiave 64x64

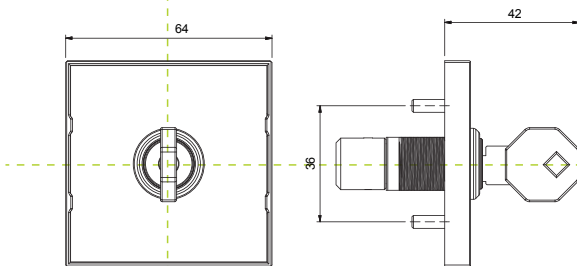

Small Oval Handle 48x48
Manopola Ovale Piccola 48x48

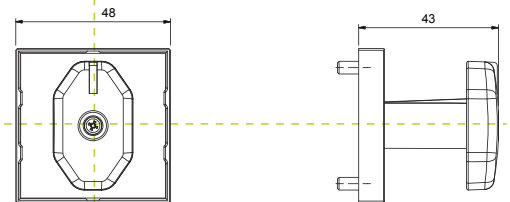

Small Pistol Grip Handle 64x64
Manopola a Pistola Piccola 64x64

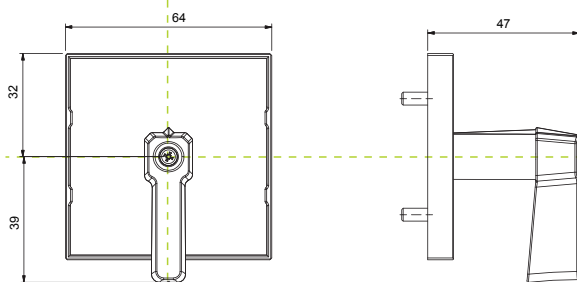

Big Padlockable Handle 64x64 (Trip Indicator)
Manopola Lucchettabile Grande 64x64

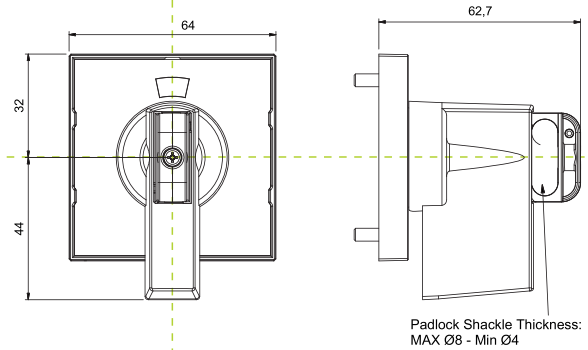

Big Oval Handle 48x48
Manopola Ovale Grande 48x48

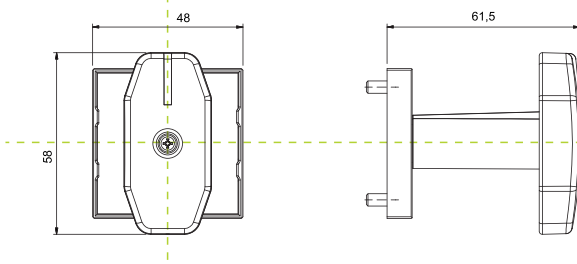

DR110 Discrepancy Switches Models:

Discrepancy switch.

New fitting system facilitated by the 5 holes.

Escutcheon plates available in different colours.

Manipolatore comando conferma.

Il nuovo sistema di fissaggio al pannello a 5 fori agevola

l'operazione di fissaggio. Targhette disponibili in varie colorazioni.

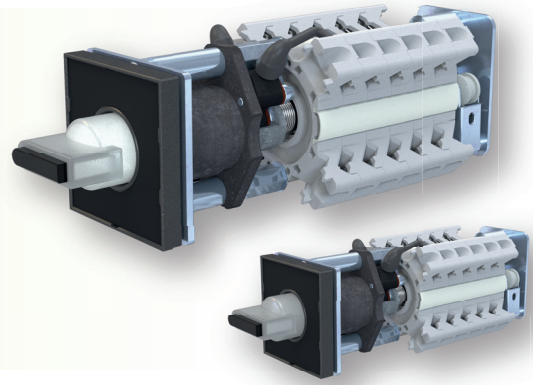

Dimensions

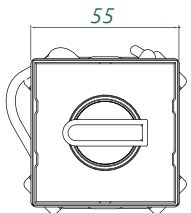

Square Frontplate

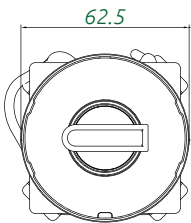

Round Frontplate

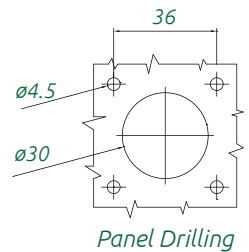
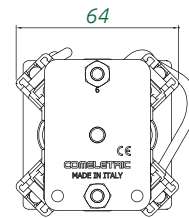
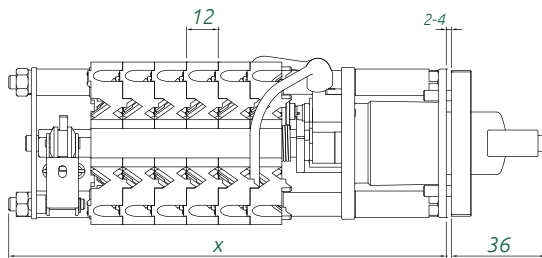

Panel Drilling

N° of packets	1	2	3	4	5	6	7	8	9	10	11	12
Length (mm)	129	141	153	165	177	189	201	213	223	237	249	261

DR110 Frontplates DR110 Mostrine

COLOR
h s f CODE

55 mm

- Q010
- Q020
- Q108
- Q116
- Q124
- Q132
- Q140
- Q148

COLOR
h s f CODE

Ø62 mm

- T010
- T020
- T108
- T116
- T124
- T132
- T140
- T148

COLOR
h s f CODE

55 mm

- Q044
- Q052
- Q060
- Q068
- Q076
- Q084
- Q092
- Q100

COLOR
h s f CODE

Ø62 mm

- T044
- T052
- T060
- T068
- T076
- T084
- T092
- T100

COLOR
h f CODE

- CODE
- CODE
- CODE
- CODE
- CODE

COLOR
h f CODE

- CODE
- CODE
- CODE
- CODE
- CODE

COLOR
h f CODE

- CODE
- CODE
- CODE
- CODE
- CODE

h=handle; f=frontplate
s=strip; s=striscia
h=manopola; f=mostrina

DR115 Discrepancy Switches Models:

Discrepancy switch.

New fitting system facilitated by the 5 holes.

Escutcheon plates available in different colours.

Frontplate size

mm 48x48 or

Ø mm 48

Manipolatore comando conferma.

Il nuovo sistema di fissaggio al pannello a 5 fori agevola

l'operazione di fissaggio. Targhette disponibili in varie colorazioni.

Misure mostrine

48x48 mm oppure

Ø 48 mm

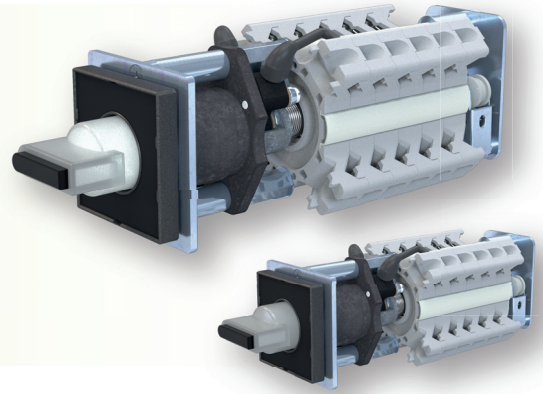

Dimensions

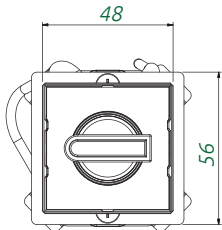

Square Frontplate

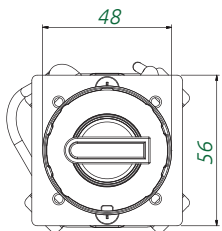

Round Frontplate

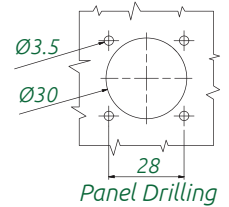
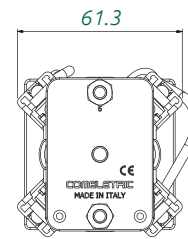
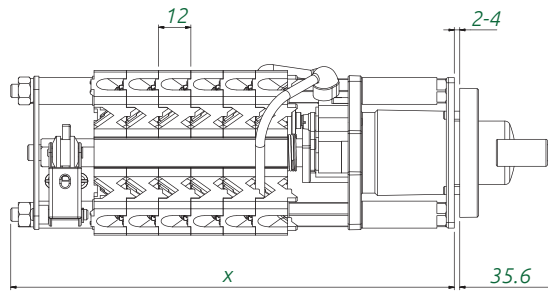

N° of packets	1	2	3	4	5	6	7	8	9	10	11	12
Length (mm)	129	141	153	165	177	189	201	213	223	237	249	261

DR115 Frontplates DR115 Mostrine

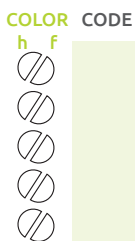
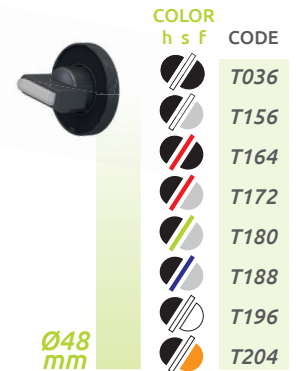
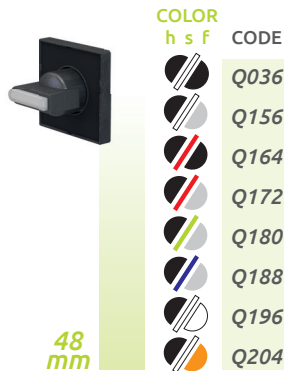
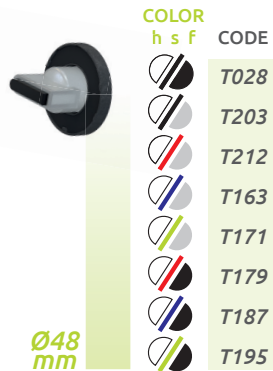
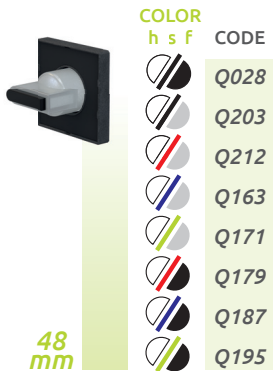

h=handle; f=frontplate
s=strip; s=striscia
h=manopola; f=mostrina

Discrepancy Switch Function and Configuration

Function	Handle Movements	Decks	Code	Connection Diagram
----------	------------------	-------	------	--------------------

Indication the position of the CB or DS

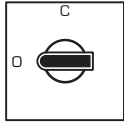
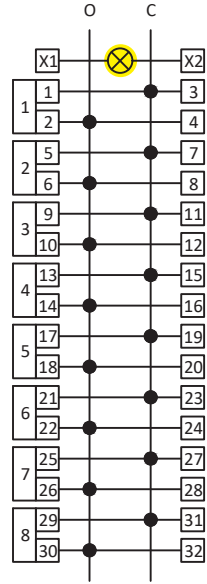
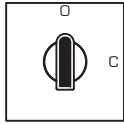
1 pole 2 pole 3 pole 4 pole 5 pole 6 pole 7 pole 8 pole		1 2 3 4 5 6 7 8	A01001 A02001 A03001 A04001 A05001 A06001 A07001 A08001	
1 pole 2 pole 3 pole 4 pole 5 pole 6 pole 7 pole 8 pole		1 2 3 4 5 6 7 8	A01003 A02003 A03003 A04003 A05003 A06003 A07003 A08003	

Indication the position of the CB or DS

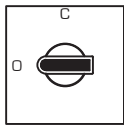
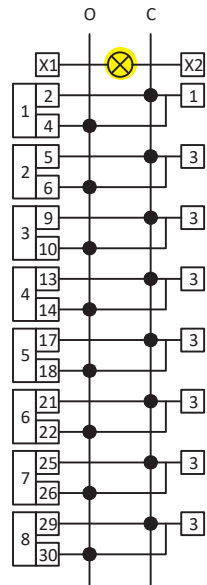
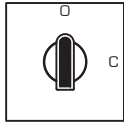
1 pole 2 pole 3 pole 4 pole 5 pole 6 pole 7 pole 8 pole		1 2 3 4 5 6 7 8	B01001 B02001 B03001 B04001 B05001 B06001 B07001 B08001	
1 pole 2 pole 3 pole 4 pole 5 pole 6 pole 7 pole 8 pole		1 2 3 4 5 6 7 8	B01003 B02003 B03003 B04003 B05003 B06003 B07003 B08003	

Discrepancy Switch Function and Configuration

Function	Handle Movements	Decks	Code	Connection Diagram
----------	------------------	-------	------	--------------------

Control and indication of CB or DS

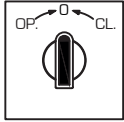
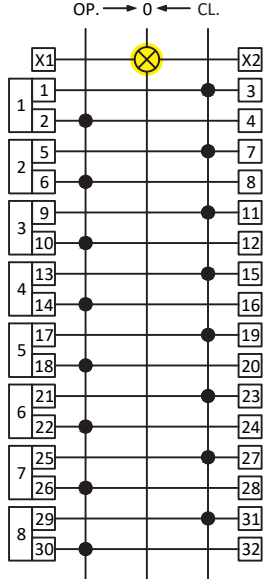
1 pole 2 pole 3 pole 4 pole 5 pole 6 pole 7 pole 8 pole		1 2 3 4 5 6 7 8	C01001 C02001 C03001 C04001 C05001 C06001 C07001 C08001	
--	---	--------------------------------------	--	--

Control and indication of CB or DS

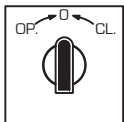
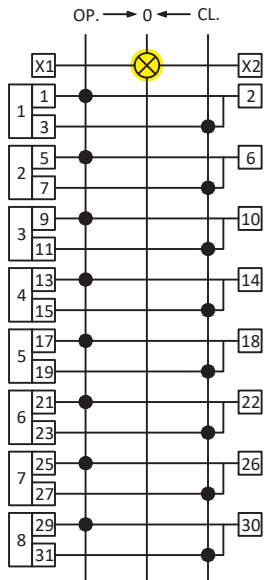
1 pole 2 pole 3 pole 4 pole 5 pole 6 pole 7 pole 8 pole		1 2 3 4 5 6 7 8	C01003 C02003 C03003 C04003 C05003 C06003 C07003 C08003	
--	---	--------------------------------------	--	---

Discrepancy Switch Function and Configuration

Principio di operazione Tipo : D ed E

I manipolatori con l'azionamento tipo D ed E sono tipicamente chiamati Manipolatori di comando e segnalazione di discordanza.

Questi Manipolatori Hanno 2pos. con spostamento di 90° e 2 extra impulsi di 45° per il comando di Apertura e di chiusura.

La manopola viene ruotata di 90° per comandare il relativo Interruttore /Sezionatore.

Questa tuttavia e' solamente una fase di preselezione del comando , il comando viene confermato tramite la pressione della manopola e la relativa rotazione , una volta rilasciata la manopola essa ritorna automaticamente nella relativa posizione.

Principle of operation Type : D and E

The switches with the movements type D and E are basically called control discrepancy switches.

The control discrepancy switch has two fixed positions with a movement of 90° and two extra impulses of 45° on the positions of open and close.

The knob is first rotated by 90° to command the relative Disconnecter Switch/Circuit Breaker.

This is however, a "pre-selection" phase of the desired command , the operation is confirmed by pressing and rotating the knob by 45°, which, once released, will return automatically into position.

Handle Movements	Code	Connection Diagram	Handle Movements	Code	Connection Diagram
	D02001			D02006	
	D02008			D02009	
	D03001			D03002	
	D03008			D03015	
	D0300621			D0300612	
	D0301821			D0301812	

Discrepancy Switch Function and Configuration

Handle Movements	Code	Connection Diagram	Handle Movements	Code	Connection Diagram
	D04001			D04002	
	D04008			D04015	
	E04001			D05001	
	XXXXX			D05008	
	D05002			D06001	
	D05015			D06008	
	D06002			E06001	
	D06015			XXXXXX	

Discrepancy Switch Function and Configuration

La mostrina si intende parte integrante del commutatore in quanto necessaria per il fissaggio al pannello dello stesso, se non specificata nessuna incisione essa verrà fornita Neutra, codice 00000.

The Escutcheon plate is strictly necessary for fitting the switch to the panel, if none engraving is specified, the frontplate will be supplied Blank, code 00000. The engraving listed below, are only a little part of those available, require the code of the needed one if not present.

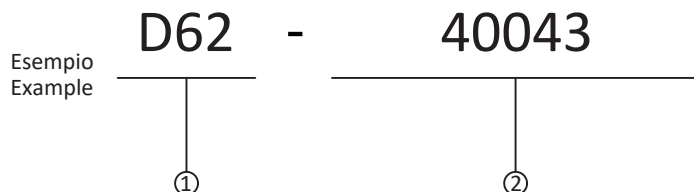

① Dimensions and shape of the Escutcheon Plate for Discrepancy Switches.

48= 48x48mm Square / Quadra

D48= 48mm Round / Tonda

55= 55x55mm Square / Quadra

D62= 62.5mm Round / Tonda

②

2 Positions

 20002	 20256	 20264	 20299	 20584	 20585	 20586	 20587	 20588	 20589
 20590	 20022	 20001	 20591	 20488	 20592	 20593	 20594	 20595	

3 Positions

 30012	 30065	 30024	 30667	 30154	 30021	 30140	 30052	 30010	 30186
-----------	-----------	-----------	-----------	-----------	-----------	-----------	-----------	-----------	-----------

4 Positions

 40043	 40044	 40058	 40059	 40060	 40079	 40094	 40097	 40103	 40126
 40252	 40121	 40095	 40175	 40127	 40156	 40088	 40253	 40254	 40257
 40258	 40227	 40256	 40259	 40255	 40260				

Gilded Contacts
Contatti Dorati

Description
Descrizione



To Improve the reliability and the performances, even in the most aggressive environments, contacts can be supplied with special surface treatments, such as gold with thickness certificate.

Per migliorare l'affidabilità e le prestazioni anche negli ambienti più aggressivi, è possibile fornire i contatti con speciali trattamenti superficiali, con spessori Certificati (es. oro).

Legend Label
Mostrina Addizionale Titolo

Description
Descrizione

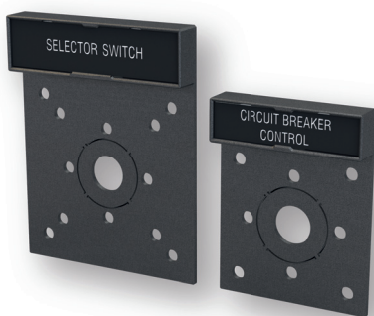

It shows the function of the switch. Available for frontplates sized mm.48x48 and mm.64x64. It does not require any extra drilling on the panel.

Indica la funzione specifica del singolo commutatore disponibile per mostrina mm.48x48 e per mostrina mm.64x64. Non necessita nessuna foratura pannello supplementare per il fissaggio.

Led Indicator
Indicatori a Led

Description
Descrizione



On demand it can be supplied with 1 or 2 LED positioned on the plate, suitable for a light indication.

Su richiesta possono essere forniti 1 o 2 indicatori LED applicati sulla mostrina da utilizzare come indicazione luminosa.

IP55 Protection
Guarnizioni IP55

Description
Descrizione

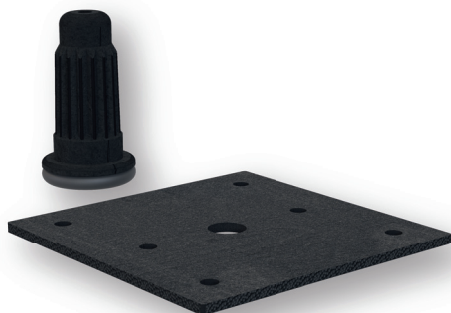

To ensure IP55 degree protection in the front of the switch, a gum plate is provided to be fitted below the frontplate Holder (not available for R104/R107).

Per assicurare il grado di protezione IP55 sul fronte del commutatore, viene fornita una guarnizione in gomma posta sotto il portamostrina (non disponibile per R104/R107).

**STANDARD UTILIZATION CATEGORIES
CATEGORIE DI UTILIZZO NORMALIZZATE**

Kind of current Tipo di corrente	Category Categoria	Typical applications Applicazioni tipiche
Alternative current Corrente alternata	AC14	Control of small electromagnetic load with rated power = 72VA Comando di piccoli carichi elettromagnetici con potenza = 72VA
	AC15	Control of electromagnetic load with rated power > 72VA Comando di carichi elettromagnetici con potenza > 72VA
	AC22	Switching of mixed resistive and inductive loads , including moderate overload Manovra di carichi misti , resistivi e induttivi con sovraccarichi di modesta entità
	AC23	Switching of motor loads or other highly inductive loads Manovra di motori o altri carichi altamente induttivi.
Direct current Corrente continua	DC13	Control of electromagnets Comando di elettromagneti
	DC14	Control of electromagnetic loads having economy resistor in circuit Comando di carichi elettromagnetici aventi resistori economizzatori nel circuito
	DC21	Switching of resistive loads including moderate overloads Manovra di carichi resistivi con sovraccarichi di moderata entità
	DC23	Switching of highly inductive loads (e.g. Series Motor) Manovra di carichi altamente induttivi (es. Motori in serie)

NORMAL CONDITIONS CONDIZIONI NORMALI				
Utilization category Categoria utilizzazione	Make Chiusura	Break Interruzione	U/Ue	cos Φ
	I/le	I/le		
AC14	6	1	1	0.3
AC15	10	1	1	0.3
AC22	1	1	1	0.8
AC23	1	1	1	0.65
				T _{0.95} [ms]
DC13	1	1	1	6xP
DC14	10	1	1	15
				L/R ms
DC21	1	1	1	1
DC23	1	1	1	7.5

ABNORMAL CONDITIONS CONDIZIONI ANOMALE			
Make Chiusura	Break Interruzione	U/Ue	cos Φ
6	6	1.1	0.7
10	10	1.1	0.3
3	3	1.05	0.65
10	8	1.05	0.45
			T _{0.95} [ms]
1.1	1.1	1.1	6xP
10	10	1.1	15
			L/R ms
1.5	1.5	1.05	1
4	4	1.05	15

- I / I_e : Current to be made or broken and Rated operational current ratio;
rapporto tra la corrente che l'apparecchiatura è in grado di stabilire o interrompere e la corrente d'impiego;
- U / U_e : Voltage before make and Rated operational voltage ratio;
rapporto tra la tensione prima della chiusura e la tensione d'impiego;
- T_{0.95}: Time to reach 95% of the steady-state current;
Tempo per raggiungere il 95% della corrente di regime;
- P=U_e x I_e: steady-state power consumption in W;
potenza assorbita a regime in W;

The value "6xP" result from empirical relationship which is found to represent most d.c. magnetic loads to an upper limit of P =50W, i.e. 6 x P=300 ms. Load having power –consumption greater than 50 W are assumed to consist of smaller loads in parallel. Therefore,300 ms is to be an upper limits irrespective of the power. **[REFERENCE STANDARD IEC 947-5-1 tab. 5].**

La relazione matematica "6xP" è valida per tutti carichi induttivi rappresentativi fino ad un massimo di P pari a 50W cioè 6xP = 300ms. Si assume che i carichi aventi una potenza assorbita superiore a 50W siano costituiti da piccoli carichi in collegati in parallelo di conseguenza 300ms è il valore massimo a prescindere dalla potenza assorbita. **[RIFERIMENTO NORMA CEI EN 60947-5-1 tab. 5]**

**RATED ELECTRICAL CHARACTERISTICS
CARATTERISTICHE ELETTRICHE NOMINALI**

According to standards Conformità alle norme	IEC 60947-3 - IEC 60947-5-1 - IEC 60947-1 - CEI EN 60947-3 - CEI EN 60947-5-1 - CEI EN 60947-1 - VDE 0660-100 - VDE 0660-107 - VDE 0660200 - 2006/95/EC (Low Voltage Directive) - 2004/108/EC (EMC Directive) - 20011/65/EU (ROHS Directive)	
Conventional free air thermal current Corrente convenzionale termica in aria	(I _{th})	25A
Rated insulation voltage Tensione di isolamento nominale	(U _i)	690V
Rated impulse withstand voltage Tensione di tenuta ad impulso nominale	(U _{imp})	4Kv
Dielectric test voltage corresponding to the rated insulation Voltage Tensione di prova corrispondente alla tensione di isolamento nominale	2500 V/60s (50Hz)	
Frequency Frequenza di impiego	50/60Hz	

**RELEVANT INFORMATIONS ABOUT THE ASSOCIATED SHORT CIRCUIT PROTECTIVE DEVICE
DATI RELATIVI AL DISPOSITIVO DI PROTEZIONE CONTRO IL CORTO CIRCUITO ASSOCIABILE**

Rated conditional short-circuit current (Max Peak current) Massima Corrente di picco ammissibile	1550A
Rated Maximum Joule integral Integrale di Joule massimo	38 kA ² s
Rated Short.time current Corrente nominale di breve durata (1s) (I _{cw})	300 A
Contact Resistance Resistenza di contatto	2.5 mΩ

**MAKING AND BREAKING CAPACITIES
POTERI DI CHIUSURA ED INTERRUZIONE**

Categoria di utilizzazione Utilization Category	(U _e)	(I _e)
AC14	400 V	16 A
AC15	400 V	10 A
A 22A (3 poli - 3 phase)	415 V	25 A
AC 23A (3 poli - 3 phase)	415 V	20 A
DC13	220 V	6 A
DC14	110 V 250 V	6 A 2.5 A
DC21A	220 V	16 A
DC23A	220 V	6 A

**RESISTANCE TO SHOCK AND VIBRATION (IEC 61373 - CEI EN 61373 Railway applications, Rolling stock equipment)
RESISTENZA VIBRAZIONI E URTI (IEC 61373 - CEI EN 61373 Applicazioni ferroviarie, materiale rotabile).
(Excluding models DR110-DR115) - (Esclusi i modelli DR110-DR115)**

Vibration resistance Resistenza alla vibrazione	Vibration Range: 5 to 150Hz, Acceleration: 5,72m/s ² , Time: 5h (in 3 directions) Range di frequenza da 5 a 15Hz, Accelerazione: 5,72m/s ² , Tempo: 5h (in 3 direzioni)
Shock resistance Resistenza agli urti	Acceleration: 50m/s ² (in 6 directions) , Time: 30ms Accelerazione: 50m/s ² (in 6 direzioni) , Tempo: 30ms



Recommended tightening torque to avoid thread stripping
Don't exceed torque more than indicated.

Coppia di serraggio consigliata per evitare di rovinare il filetto della vite
Non superare la coppia più di quanto indicato.

Conneting screw Vite di contatto terminale	M 3.5
Tightening torque Coppia serraggio viti	(Nm) 1.2
Permissible wire gage Sezione del conduttore	
Single - core or stranded wire Cavo rigido o intrecciato	(mm ²) 1.5 - 6 AWG15 - AWG9
Flexible wire Cavo flessibile	(mm ²) 1.5 - 6 AWG15 - AWG9

**ENVIRONMENTAL DATA (IEC 60947-1 - CEI EN 60947-1)
DATI AMBIENTALI**

Temperature range Temperatura ambientale	
Operating temperature Esercizio	-25°C +60°C
Storage temperature Stoccaggio	-40°C +80°C

R167 Push Button Interlock Switch
R167 Interblocco a Pulsante

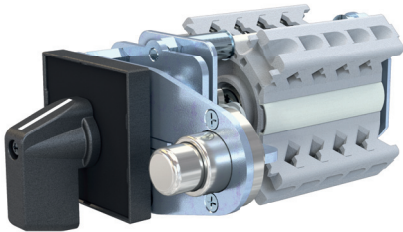

The switch can be handle only by pressing the push button (2 hands operation).

Il commutatore può essere manovrato solo premendo il pulsante di blocco (operazione a 2 mani).

SR106 Solenoid lock switch
SR106 con interblocco elettromeccanico

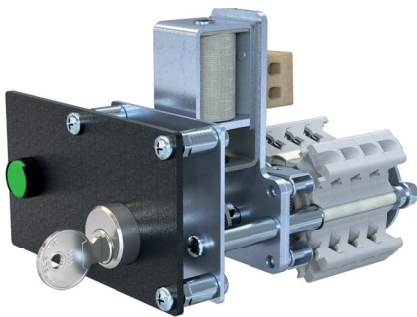

It is used as interlocking device for disconnect, circuit breaker, earth switches or to control the access to dangerous areas such as capacitor banks, etc.. The switch can be activated manually through a push button integrated in the front plate that controls the coil. At the end of this operation it is possible to remove the key.

REFERE TO INTERLOCKING DEVICE CATALOGUE.

L'apparecchio viene utilizzato come interblocco elettromagnetico per sezionatori, interruttori, sezionatori di terra o per regolamentare l'accesso a zone pericolose come banchi di condensatori, ecc. Il commutatore può essere azionato tramite comando manuale di un pulsante integrato nella mostrina che eccita la bobina, a fine operazione diventa possibile l'estrazione della chiave.

FARE RIFERIMENTO AL CATALOGO INTERBLOCCHI.

SR105 Solenoid lock switch
SR105 con interblocco elettromeccanico

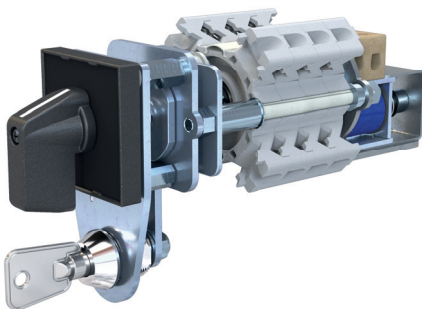

This is a special switch with a double block both mechanical and electrical, through the coil energized on the rear of it.

Questo commutatore sfrutta un doppio blocco meccanico ed elettrico, grazie all'eccitazione della bobina posta sul retro.

R101 Unidirectional Switch
R101 Rotazione unidirezionale

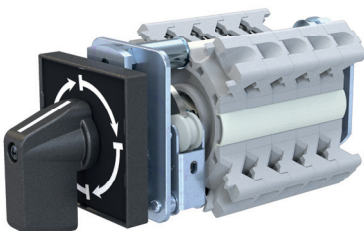

Available for switches with 4 positions at 90° or 8 positions at 45° It can be handled only clockwise or counterclockwise.

Disponibile per commutatori a 4 posizioni a 90° o 8 posizioni a 45°. Abilita la rotazione solamente in senso orario o antiorario.

C-R20 06/18

Via Ernesto Rizzi 13/H
20077 Melegnano (MI) Italia
T +39 02.98119791
info@comeletric.it
P iva 00868300153

COMELETRIC.IT

