

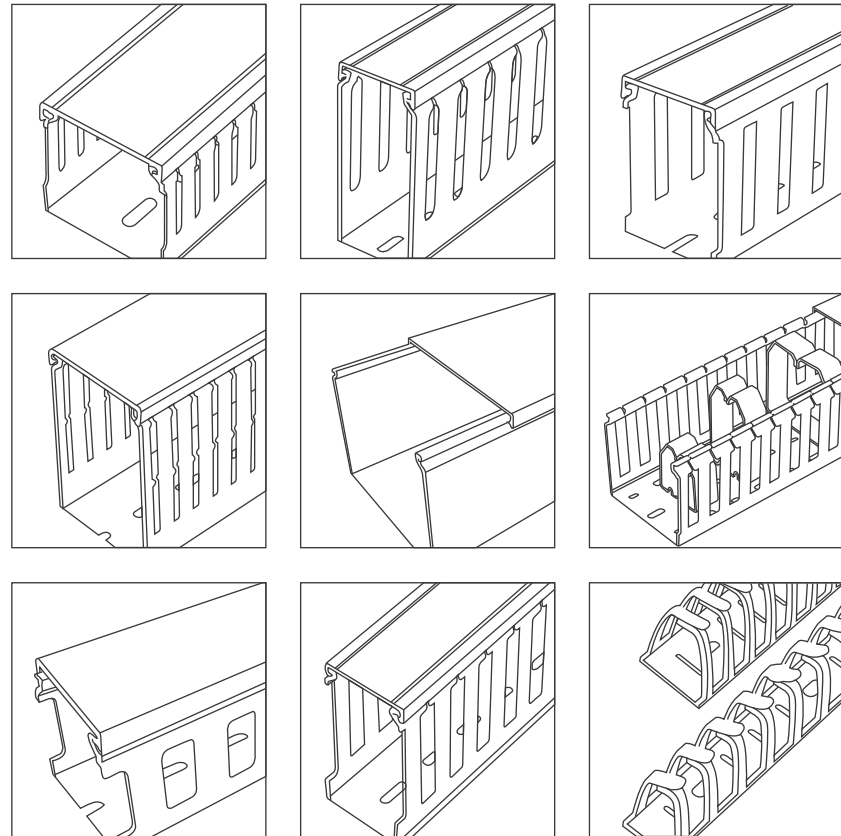

YF NEW MATERIALS





上海·轶峰

股票代码: 839754



Green Plant

SACOM - Southern Asia Commercial Joint Stock Company, is a leading supplier/distributor of electrical panel accessories and other products in Vietnam. We are partners with more than ten electrical brands worldwide. We have long-term business relationships with 300+ customers in Asia with more than 20 years of cooperation and experience with product sales networks. SACOM always seeks to establish a mutually beneficial trading relationship with her customers.



S A C O M

Company Information

Shanghai Yifeng New Materials Ltd was founded in 2009, Located at Fengxian District, Shanghai, We are an innovative company focused on developing, manufacturing and selling electrical accessories.

We are dedicated to developing and manufacturing products for the continuously upgrading electrical wiring segment, and we are company in China who applied new materials and technologies to the segment. Yifeng has achieved many patents and qualifications which keep improving and optimizing our products in terms of features and efficiency. These achievements add remarkable value and competitiveness to our customers in industries of high-speed trains, rail transits, nuclear powers, new energies, ships and marine, aerospace, power delivery, machinery, lathe, automations and so on.

Yifeng takes advantages of new technologies and manufacturing processes, and strictly follows ISO 9001 in quality management. Our products are certified with UL, CE, CCC, RoHS, Din 5510-2, EN45545 and QCRR, and we are the leading company in China with high quality products in the wiring segment. Our innovation deserves your trust.

OUR GROWTH

Patents & Qualifications



Catalogue

TABLE OF CONTENTS

Low smoke halogen free	1-6
L-UD/RVD/R Low smoke halogen free enhanced PC+ABS duct	3-4
L-VD/L-UD Low smoke halogen-free wiring duct	5-6
SWD flame retardant wiring duct	7-16
SWD flame retardant wire channel (Open Coarse type)	9-10
SWD flame retardant wire groove (open fine tooth type)	11-12
SWD flame retardant wiring duct (closed type)	13-14
MD wire trunk (fully enclosed)	15-16
Non-slip flame retardant wiring duct	17-28
N-UD Non-slip UL wire groove (open coarse tooth type)	19-20
N-VD non-slip UL wire groove (open fine tooth type)	21-22
N-OFD non-slip UL wire groove (square closed type)	23-24
N-UFD/VFD Non-slip UL Trough (Double-Separated Teeth)	25-26
N-MD Non-slip UL Trough (Totally Enclosed Type)	27-28
Trunk accessories	29-38
SWD-KB wire cover / L/R-KB reinforced Low smoke halogen-free wire cover	31-32
L-KB Low smoke halogen wire cover / N-KB UL non-slip wire cover	33-34
DS flexible keel duct / FD series pull-out duct	35-36
Wire Tools/Cable Retaining Clips	37-38
Accessories	39-48



YIFENG NEW MATERIALS



Low smoke Halogen free

Made from PC+ABS macromolecule polymer materials which are low smoke, halogen free, and are environmentally friendly and flame retardant.

L-UD/R VD/R LSZH are reinforced PC+ABS wiring ducts

L-VD/L-UD LSZH are low smoke halogen free wiring ducts



L-UD/R VD/R

Low-smoke halogen-free,
new reinforced type PC+ABS wiring duct



Wiring Duct

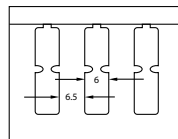

L-VD/R LSZH wiring duct (low smoke halogen free type)

Type	mm		Slot Width mm	Sliver Width mm	Wires to be Contained Line capacity (in 2.0 square meters)	Packing M
	H	W				
L-VD/R 25/25	25	25	6	6.5	10-25pcs	100
L-VD/R 37.5/37.5	37.5	37.5	6	6.5	15-30pcs	100
L-VD/R 37.5/50		50	6	6.5	20-35pcs	100
L-VD/R 50/25	50	25	6	6.5	20-30pcs	100
L-VD/R 50/37.5		37.5	6	6.5	20-35pcs	80
L-VD/R 50/50		50	6	6.5	80-90pcs	80
L-VD/R 50/75		75	6	6.5	180-200pcs	48
L-VD/R 50/100		100	6	6.5	220-250PCS	48
L-VD/R 75/25	75	25	6	6.5	50-55pcs	60
L-VD/R 75/37.5		37.5	6	6.5	110-115pcs	60
L-VD/R 75/50		50	6	6.5	180-200pcs	48
L-VD/R 75/75		75	6	6.5	200-250pcs	36
L-VD/R 75/100		100	6	6.5	260-320pcs	24

Product updates can be found on the website data



Description

- **Materials**
PC+ABS, halogen free, Low smoke, RoHS compliant, Insulating material, which are tested for electrical and fire safety.
- **Flammability rating**
UL 94 V - O
- **Compliance**
Complies with EN 45545, DIN 5510-2
- **Temperature**
-40°C~90°C
- **Construction**
 1. Features thick sides, with enhanced quality from top to bottom, improving strength and reliability.
 2. Features double layers of halogen free materials used for the joints of covers and sides, enhancing durability, and making it easier to disassemble.
 3. Features a right-angle curvature at the bottom that is designed to be flexible and to easily unfold, making it easier to cut and unfold for wire exits. This keeps the wire safely arranged.
 4. The floor has rails, providing the opportunity to add traps to tighten wires in-order to make it organized, neat and space efficient.

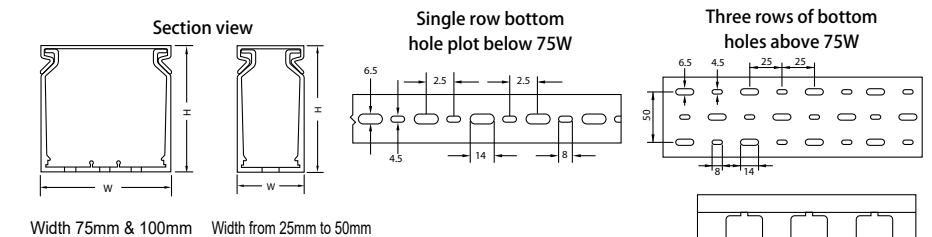
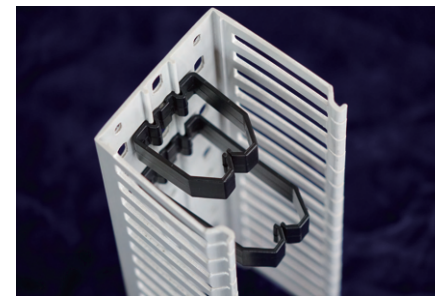

Width 75mm & 100mm Width from 25mm to 50mm

L-UD/R LSZH wiring duct (reinforced PC+ABS)

Type	mm		Slot Width mm	Sliver Width mm	Wires to be Contained Line capacity (in 2.0 square meters)	Packing M
	H	W				
L-UD/R 37.5/37.5	37.5	37.5	10	10	15-30pcs	100
L-UD/R 37.5/50		50	10	10	20-35pcs	100
L-UD/R 50/25	50	25	10	10	20-30pcs	100
L-UD/R 50/37.5		37.5	10	10	20-35pcs	80
L-UD/R 50/50		50	10	10	80-90pcs	80
L-UD/R 50/75		75	10	10	180-200pcs	48
L-UD/R 50/100		100	10	10	220-250PCS	48
L-UD/R 75/25	75	25	10	10	50-55pcs	60
L-UD/R 75/37.5		37.5	10	10	110-115pcs	60
L-UD/R 75/50		50	10	10	180-200pcs	48
L-UD/R 75/75		75	10	10	200-250pcs	36
L-UD/R 75/100		100	10	10	260-320pcs	24

Product updates can be found on the website data

L-VD/L-UD

L-UD low smoke halogen-free

wiring duct (open thick tooth)



Wiring Duct

L-UD low smoke halogen-free wiring duct (open thick tooth)

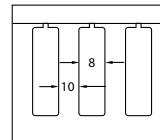

Type	mm		Slot Width mm	Sliver Width mm	Wires to be Contained Line capacity (in 2.0 square meters)	Packing M
	H	W				
L-UD 35 35	35	35	8	10	20-25pcs	100
L-UD 40 25	40	25	8	10	20-30pcs	100
L-UD 40 40		40	8	10	60-70pcs	100
L-UD 40 60		60	8	10	100-115pcs	64
L-UD 40 80		80	8	10	120-135pcs	48
L-UD 50 35	50	35	8	10	40-60pcs	100
L-UD 50 50		50	8	10	80-90pcs	80
L-UD 50 80		80	8	10	160-180pcs	48
L-UD 80 25		80	25	8	10	100-120pcs
L-UD 80 30	30		8	10	105-125pcs	60
L-UD 80 35	35		8	10	110-130pcs	60
L-UD 80 40	40		8	10	140-160pcs	48
L-UD 80 45	45		8	10	140-165pcs	48
L-UD 80 50	50		8	10	160-180pcs	48
L-UD 80 60	60		8	10	180-210pcs	36
L-UD 80 80	80		8	10	240-290pcs	36
L-UD 80 100	100		8	10	260-350pcs	24
L-UD 80 120	120		8	10	280-380pcs	24

Product updates can be found on the website data



Description

- Material**
Made from PC+ABS, halogen free, Low smoke, RoHS compliant, insulating material, which is tested for electrical and fire safety.
- Flammability rating**
UL94V-0, Non-flame propagator.
- Compliance**
Complies with EN45545, DIN5510-2
- Construction**
 1. Features a base and cover, Easy, firm, snap on assembly, and smooth joining for a better finish.
 2. Features aligned ducts, smooth corners and edges which ensures good wire arrangements, malleability, and longevity.
 3. Features on all sides versatile mounting holes, making the unit easy to assemble, install, uninstall and disassembly.
 4. Features a special mark line design on the cover which allows a quick tag of relevant components
- Color**
Grey RAL 7035
- Temperature**
-40°C~90°C

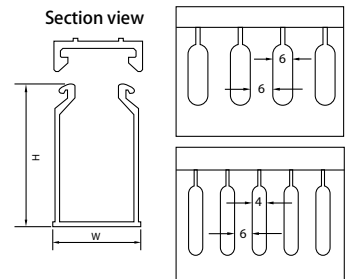
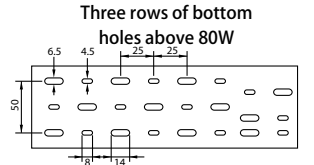
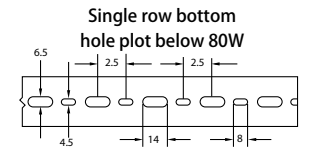

L-VD low smoke halogen-free wiring duct (open fine-tooth type)

Type	mm		Slot Width mm	Sliver Width mm	Wires to be Contained Line capacity (in 2.0 square meters)	Packing Mt	
	H	W					
L-VD 40 25	40	25	4	6	20-25pcs	100	
L-VD 40 40		40	4	6	60-70pcs	100	
L-VD 40 60		60	4	6	100-115pcs	64	
L-VD 40 80		80	4	6	120-135pcs	48	
L-VD 50 35	50	35	4	6	40-60pcs	100	
L-VD 50 50		50	4	6	80-90pcs	80	
L-VD 50 80		80	4	6	160-180pcs	48	
L-VD 60 25		60	25	4	6	40-55pcs	80
L-VD 60 30	30		4	6	40-65pcs	80	
L-VD 60 40	40		4	6	100-115pcs	64	
L-VD 60 60	60		4	6	120-135pcs	48	
L-VD 60 80	80		4	6	180-210pcs	36	
L-VD 80 25	80		25	4	6	100-120pcs	60
L-VD 80 30		30	4	6	105-125pcs	60	
L-VD 80 35		35	4	6	110-130pcs	60	
L-VD 80 40		40	4	6	140-160pcs	48	
L-VD 80 45		45	4	6	140-165pcs	48	
L-VD 80 50		50	4	6	160-180pcs	48	
L-VD 80 60		60	4	6	180-210pcs	36	
L-VD 80 80		80	4	6	240-290pcs	36	
L-VD 80 100		100	4	6	260-350pcs	24	
L-VD 80 120		120	4	6	280-380pcs	24	
L-VD 100 40		100	40	6	6	130-175pcs	48
L-VD 100 50			50	6	6	220-250pcs	48
L-VD 100 60	60		6	6	240-290pcs	32	
L-VD 100 75	75		6	6	260-350pcs	24	
L-VD 100 100	100		6	6	300-400pcs	24	

Product updates can be found on the website data



YIFENG NEW MATERIALS



SWD flame retardant Wiring Duct

Made from high-quality rigid PVC, which has passed ROHS certification and does not contain harmful substances such as lead and asbestos.

- SWD flame retardant wiring groove (open coarse tooth type)
- SWD flame retardant wiring duct (open fine-tooth type)
- SWD flame retardant wiring duct (closed type)
- MD wire trunk (fully enclosed)



SWD

SWD flame retardant wiring duct
(Open coarse tooth type)



Wiring Duct

Description

- Material**
Features an environmentally friendly and high-quality rigid PVC, which has passed ROHS certification and does not contain harmful substances such as lead and asbestos..
- Flammability rating**
UL94 V-0 flame retardant grade, self-extinguishing, and good insulation properties.

- Construction**
 1. Features a base and cover, Easy, firm, snap on assembly, and smooth joining for a better finish.
 2. Features aligned ducts, Smooth corners and edges which ensures good wire arrangements, malleability, and longevity
 3. Features on all sides, versatile mounting holes, making the unit easy to, assemble, install, uninstall and disassembly.
 4. Features a special mark line design on the cover which allows a quick tag of relevant components
 5. The line design on the bottom edge, allows easy wire duct, and malleability.

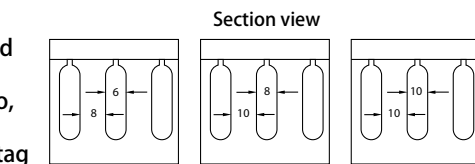
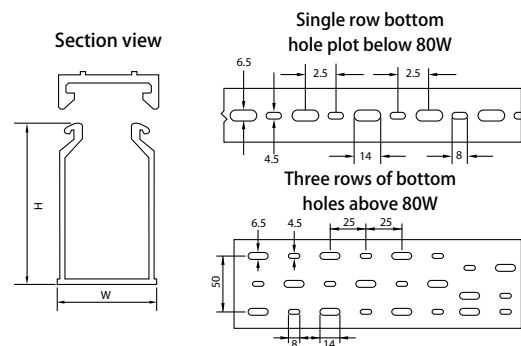

- Color**
Available Colours which can be customized are (Grey, White, Blue, and Black)

- Temperature**
-20°C~65°C

SWD flame retardant wiring duct (Open coarse tooth type)

Type	mm		Slot Width mm	Sliver Width mm	Wires to be Contained Line capacity (in 2.0 square meters)	Packing M
	H	W				
SWD 40 25	40	25	6	8	20-25pcs	100
SWD 40 40		40	6	8	60-70pcs	100
SWD 40 60		60	6	8	100-115pcs	64
SWD 40 80		80	6	8	120-135pcs	48
SWD 45 33	45	33	6	8	40-55pcs	100
SWD 45 45		45	6	8	60-70pcs	80
SWD 50 25	50	25	6	8	20-25pcs	100
SWD 50 35		35	6	8	40-60pcs	100
SWD 50 45		45	6	8	70-80pcs	80
SWD 50 50		50	6	8	80-90pcs	80
SWD 50 55		55	6	8	90-100pcs	48
SWD 50 60		60	6	8	100-120pcs	48
SWD 50 80		80	6	8	160-180pcs	48
SWD 60 25	60	25	8	10	40-45pcs	80
SWD 60 40		40	8	10	100-115pcs	64
SWD 60 50		50	8	10	100-120pcs	48
SWD 60 55		55	8	10	115-125pcs	48
SWD 60 60		60	8	10	120-135pcs	48
SWD 60 80		80	8	10	180-210pcs	36
SWD 65 33	65	33	8	10	40-75pcs	80
SWD 65 45		45	8	10	110-120pcs	80
SWD 65 65		65	8	10	180-200pcs	48
SWD 80 25	80	25	8	10	100-120pcs	60
SWD 80 30		30	8	10	105-125pcs	60
SWD 80 35		35	8	10	110-130pcs	60
SWD 80 40		40	8	10	140-160pcs	48
SWD 80 45		45	8	10	140-165pcs	48
SWD 80 50		50	8	10	160-180pcs	48
SWD 80 60		60	8	10	180-210pcs	36
SWD 80 80		80	8	10	240-290pcs	36
SWD 80 100		100	8	10	260-350pcs	24
SWD 80 120		120	8	10	280-380pcs	24
SWD 100 25	100	25	10	10	120-150pcs	48
SWD 100 33		33	10	10	130-165pcs	48
SWD 100 35		35	10	10	130-165pcs	48
SWD 100 40		40	10	10	130-175pcs	48
SWD 100 50		50	10	10	220-250pcs	48
SWD 100 60		60	10	10	240-290pcs	32
SWD 100 80		80	10	10	260-350pcs	24
SWD 100 100		100	10	10	300-400pcs	24
SWD 100 120		120	10	10	380-480pcs	24
SWD 100 140		140	10	10	430-620pcs	16
SWD 130 100	130	100	10	420-600pcs	16	
SWD 140 35	140	35	10	120-165pcs	24	
SWD 150 100	150	100	10	450-650pcs	16	

Product updates can be found on the website data

SWD

SWD flame retardant wiring duct
(open fine-tooth type)



Wiring Duct

Description

- **Material**
Made from high-quality rigid PVC, which has passed ROHS certification and does not contain harmful substances such as lead and asbestos.
- **Flammability rating**
UL94, V-0 flame retardant grade with good self-extinguishing properties.
- **Construction**
 1. Features a base and cover, Easy, firm, snap on assembly, and smooth joining for a better finish.
 2. Features aligned ducts, Smooth corners and edges which ensures good wire arrangements, malleability, and longevity.
 3. Features on all sides, versatile mounting holes, making the unit easy to, assemble, install, uninstall and disassembly.
 4. Features a special mark line design on the cover which allows a quick tag of relevant components.
 5. The line design on the bottom edge, allows easy wire duct, and malleability.

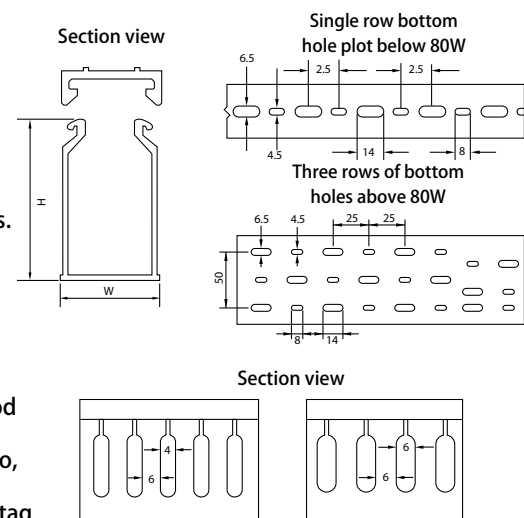

■ **Color**
Available Colours, which can be customized are (Grey, White, Blue, and Black)

■ **Temperature**
-20°C~65°C

SWD flame retardant wiring duct (open fine-tooth type)

Type	mm		Slot Width mm	Sliver Width mm	Wires to be Contained Line capacity (in 2.0 square meters)	Packing M
	H	W				
SWD 25 25	25	25	4	6	10-25pcs	100
SWD 30 15	30	15	4	6	15-20pcs	100
SWD 30 20		20	4	6	15-25pcs	100
SWD 30 25		25	4	6	15-25pcs	100
SWD 30 30		30	4	6	30-40pcs	100
SWD 30 35		35	4	6	30-45pcs	100
SWD 35 25	35	25	4	6	15-20pcs	100
SWD 35 35		35	4	6	35-50pcs	100
SWD 35 50		50	4	6	40-60pcs	100
SWD 40 25	40	25	4	6	20-25pcs	100
SWD 40 40		40	4	6	60-70pcs	64
SWD 40 60		60	4	6	100-115pcs	100
SWD 40 80		80	4	6	120-135pcs	48
SWD 50 25	50	25	4	6	20-25pcs	100
SWD 50 35		35	4	6	40-60pcs	100
SWD 50 40		40	4	6	45-75pcs	80
SWD 50 45		45	4	6	70-80pcs	80
SWD 50 50		50	4	6	80-90pcs	80
SWD 50 55		55	4	6	90-100pcs	64
SWD 50 60		60	4	6	100-120pcs	64
SWD 50 80		80	4	6	160-180pcs	48
SWD 60 25	60	25	4	6	40-45pcs	80
SWD 60 40		40	4	6	100-115pcs	64
SWD 60 50		50	4	6	100-120pcs	64
SWD 60 55		55	4	6	115-125pcs	48
SWD 60 60		60	4	6	120-135pcs	48
SWD 60 80		80	4	6	180-210pcs	36
SWD 65 33	65	33	4	6	40-75pcs	80
SWD 65 45		45	4	6	110-120pcs	80
SWD 65 65		65	4	6	180-200pcs	48
SWD 80 25	80	25	4	6	100-120pcs	60
SWD 80 30		30	4	6	105-125pcs	60
SWD 80 35		35	4	6	110-130pcs	60
SWD 80 40		40	4	6	140-160pcs	48
SWD 80 45		45	4	6	140-165pcs	48
SWD 80 50		50	4	6	160-180pcs	48
SWD 80 60		60	4	6	180-210pcs	36
SWD 80 80		80	4	6	240-290pcs	36
SWD 80 100		100	4	6	260-350pcs	24
SWD 80 120		120	4	6	280-380pcs	24
SWD 100 25	100	25	6	6	120-150pcs	48
SWD 100 33		33	6	6	130-165pcs	48
SWD 100 35		35	6	6	130-165pcs	48
SWD 100 40		40	6	6	130-175pcs	48
SWD 100 50		50	6	6	220-250pcs	48
SWD 100 60		60	6	6	240-290pcs	32
SWP 100 80		80	6	6	260-350pcs	24
SWD 100 100		100	6	6	300-400pcs	24
SWD 100 120		120	6	6	380-480pcs	24
SWD 100 140		140	6	6	430-620pcs	24

Product updates can be found on the website data

SWD

SWD flame retardant wiring duct
(closed mouth)



Wiring Duct

Description

- **Material**
Made from high-quality rigid PVC, which has passed ROHS certification and does not contain harmful substances such as lead and asbestos.
- **Flammability rating**
UL94, V-0 flame retardant grade with good self-extinguishing ability.
- **Construction**
 1. Features a base and cover, easy, firm, snap on assembly, and smooth joining for a better finish.
 2. Features aligned ducts, smooth corners and edges which ensures good wire arrangements, malleability, and longevity.
 3. Features on all sides, versatile mounting holes, making the unit easy to, assemble, install, uninstall and disassembly.
 4. Features a special mark line design on the cover which allows a quick tag of relevant components.
- **Color**
Available Colours, which can be customized are (Grey, White, Blue, and Black)
- **Temperature**
-20°C~65°C

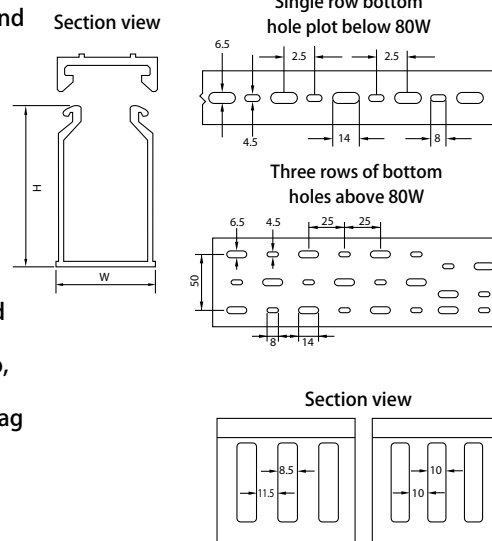

SWD flame retardant wiring duct (closed mouth)

Type	mm		Slot Width mm	Sliver Width mm	Wires to be Contained Line capacity (in 2.0 square meters)	Packing M
	H	W				
SWD 40 25	40	25	8.5	11.5	20-25pcs	100
SWD 40 40		40	8.5	11.5	60-70pcs	100
SWD 40 60		60	8.5	11.5	100-115pcs	64
SWD 40 80		80	8.5	11.5	140-160pcs	48
SWD 50 25	50	25	10	10	20-25pcs	100
SWD 50 35		35	10	10	40-60pcs	100
SWD 50 45		45	10	10	70-80pcs	80
SWD 50 50		50	10	10	80-90pcs	80
SWD 50 55		55	10	10	90-100pcs	48
SWD 50 60		60	10	10	100-120pcs	48
SWD 50 80	80	10	10	160-180pcs	48	
SWD 60 25	60	25	8.5	11.5	40-45pcs	80
SWD 60 40		40	8.5	11.5	100-115pcs	64
SWD 60 50		50	8.5	11.5	100-120pcs	48
SWD 60 55		55	8.5	11.5	115-125pcs	48
SWD 60 60		60	8.5	11.5	120-135pcs	48
SWD 60 80		80	8.5	11.5	180-210pcs	36
SWD 80 25	80	25	10	10	100-120pcs	60
SWD 80 30		30	10	10	105-125pcs	60
SWD 80 35		35	10	10	110-130pcs	60
SWD 80 40		40	10	10	140-160pcs	48
SWD 80 45		45	10	10	140-165pcs	48
SWD 80 50		50	10	10	160-180pcs	48
SWD 80 60		60	10	10	180-210pcs	36
SWD 80 80		80	10	10	240-290pcs	36
SWD 80 100		100	10	10	260-350pcs	24
SWD 80 120		120	10	10	280-380pcs	24
SWD 100 25	100	25	10	10	120-150pcs	48
SWD 100 35		35	10	10	130-165pcs	48
SWD 100 40		40	10	10	130-175pcs	48
SWD 100 50		50	10	10	220-250pcs	48
SWD 100 60		60	10	10	240-290pcs	32
SWD 100 80		80	10	10	260-350pcs	24
SWD 100 100		100	10	10	300-400pcs	24
SWD 100 120		120	10	10	380-480pcs	24
SWD 100 140	140	10	10	430-620pcs	16	

Product updates can be found on the website data

MD

MD wire trunk (Totally enclosed type)

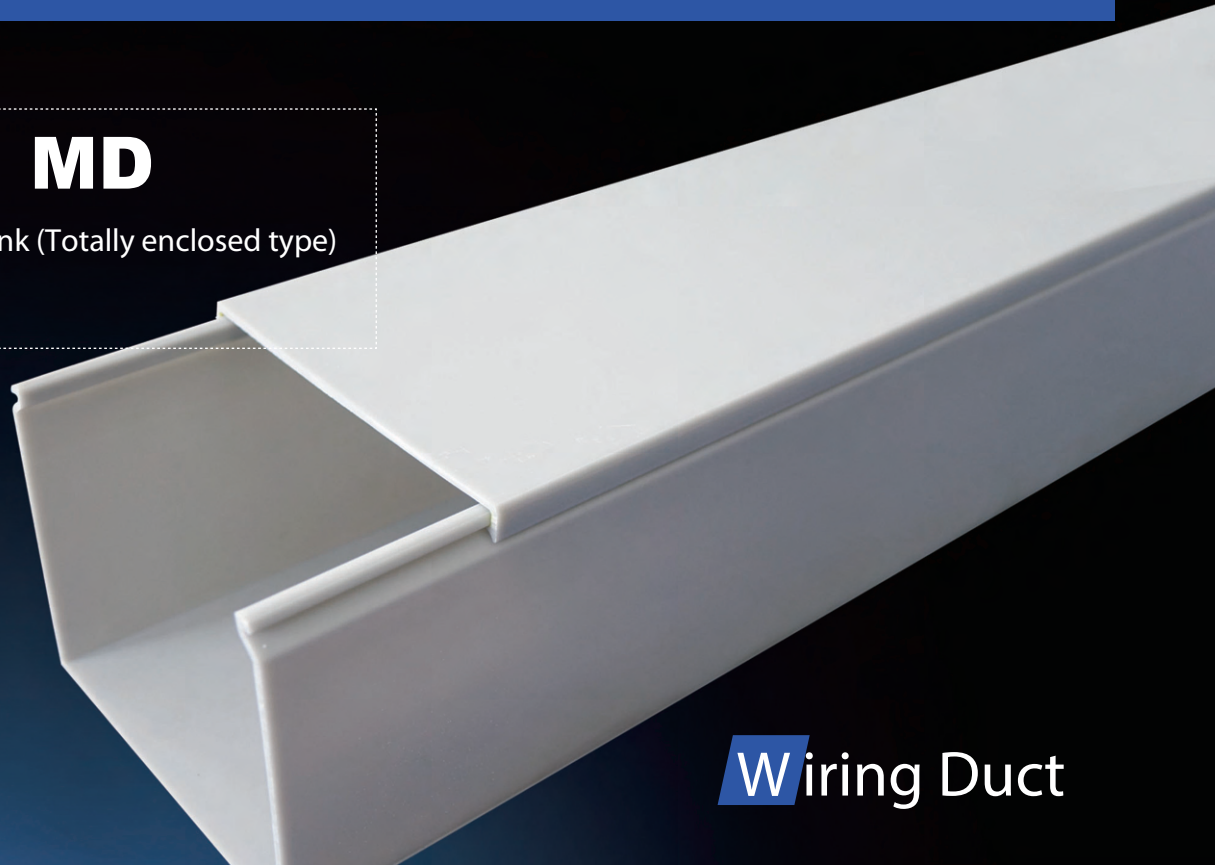

Wiring Duct

Description

- **Material**
Made from high-quality rigid PVC, which has passed ROHS certification and does not contain harmful substances such as lead and asbestos.
- **Flammability rating**
UL94, V-0 flame retardant grade with good self-extinguishing properties.
- **Construction**
 1. Features a base and cover, Easy, firm, snap on assembly, and smooth joining for a better finish.
 2. Features aligned ducts, Smooth corners and edges which ensures good wire arrangements, malleability, and longevity.
- **Color**
Available Colours which can be customized are (Grey, White, Blue, and Black)
- **Temperature**
-20°C~65°C

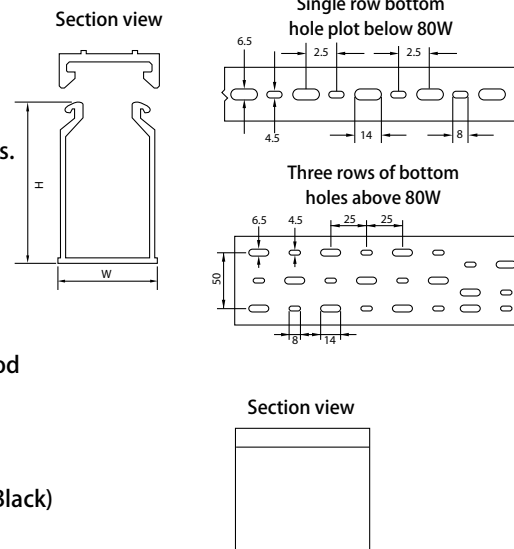

MD wire trunk (Totally enclosed type)

Type	mm		Wires to be Contained Line capacity (in 2.0 square meters)	Packing M	
	H	W			
MD 25 25	25	25	10-25pcs	100	
MD 30 15	30	15	15-20pcs	100	
MD 30 20		20	15-25pcs	100	
MD 30 25		25	15-25pcs	100	
MD 30 30		30	30-40pcs	100	
MD 30 35		35	30-45pcs	100	
MD 35 25	35	25	15-20pcs	100	
MD 35 35		35	35-50pcs	100	
MD 35 50		50	40-60pcs	100	
MD 40 25	40	25	20-25pcs	100	
MD 40 40		40	60-70pcs	100	
MD 40 60		60	100-115pcs	64	
MD 40 80		80	140-160pcs	48	
MD 45 33	45	33	40-55pcs	100	
MD 45 45		45	60-70pcs	80	
MD 50 25	50	25	20-25pcs	100	
MD 50 35		35	40-60pcs	100	
MD 50 45		45	70-80pcs	80	
MD 50 50		50	80-90pcs	80	
MD 50 55		55	90-100pcs	48	
MD 50 60		60	100-120pcs	48	
MD 50 80		80	160-180pcs	48	
MD 60 25	60	25	40-45pcs	80	
MD 60 40		40	100-115pcs	64	
MD 60 50		50	100-120pcs	48	
MD 60 55		55	115-125pcs	48	
MD 60 60		60	120-135pcs	48	
MD 60 80		80	180-210pcs	36	
MD 65 33		65	33	40-75pcs	80
MD 65 45			45	110-120pcs	80
MD 65 65	65		180-200pcs	48	
MD 80 25	80	25	100-120pcs	60	
MD 80 30		30	105-125pcs	60	
MD 80 35		35	110-130pcs	60	
MD 80 40		40	140-160pcs	48	
MD 80 45		45	140-165pcs	48	
MD 80 50		50	160-180pcs	48	
MD 80 60		60	180-210pcs	36	
MD 80 80		80	240-290pcs	36	
MD 80 100		100	260-350pcs	24	
MD 80 120		120	280-380pcs	24	
MD 100 25	100	25	120-150pcs	48	
MD 100 33		33	130-165pcs	48	
MD 100 35		35	130-165pcs	48	
MD 100 40		40	130-175pcs	48	
MD 100 50		50	220-250pcs	48	
MD 100 60		60	240-290pcs	32	
MD 100 80		80	260-350pcs	24	
MD 100 100		100	300-400pcs	24	
MD 100 120		120	380-480pcs	24	
MD 100 140		140	430-620pcs	16	
MD 120 75	120	75	280-380pcs	24	
MD 130 100	130	100	420-600pcs	16	
MD 140 35	140	35	220-300pcs	24	
MD 150 100	150	100	450-650pcs	16	

Product updates can be found on the website data



YIFENG NEW MATERIALS



UL wiring duct Non-slip

Made from high-quality rigid PVC macromolecules, and internally, non-slip polymer materials which feature elastic co-extrusion. It's RoHS compliant.

N-UD non-slip UL wire groove (open coarse tooth type)

N-VD non-slip UL wire groove (open fine-tooth type)

N-OFD non-slip UL wire groove (square closed type)

N-UFD/VFD non-slip UL wire groove (double partition tooth type)

N-MD non-slip UL wiring duct (fully enclosed)

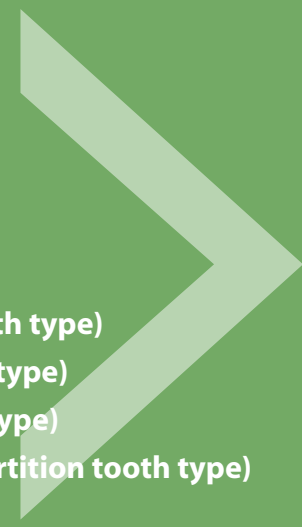

N-UD

N-UD Non-slip UL wiring duct
(Open coarse tooth type)



Description

- Material**
Made from High quality rigid PVC, RoHS compliant.
- Flammability rating**
UL94V-0, good self-extinguishing, good insulation properties.
- Construction**
 - The inner side of the cover plate is designed with co-extruded non-slip strips, which is easy to install, does not fall off at any angle, and has a width greater than or equal to 40.
 - The hole design placement is strategic to ensure easy installation and cable routing.
- Color**
Available Colours are (Grey, White, Blue, and Black), which can be customized.
- Temperature**
-20°C~65°C

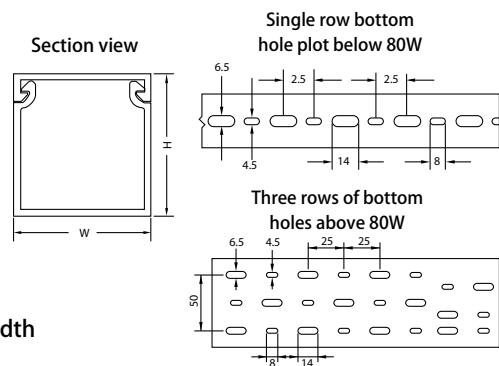

Width 40 and above are all with anti-skid strips, except 45W

N-UD Non-slip UL wiring duct (Open coarse tooth type)

Type	mm		Slot Width mm	Sliver Width mm	Wires to be Contained Line capacity (in 2.0 square meters)	Packing M	
	H	W					
N-UD 40 25	40	25	6	8	20-25pcs	100	
N-UD 40 40		40	6	8	60-70pcs	100	
N-UD 40 60		60	6	8	100-115pcs	64	
N-UD 40 80		80	6	8	140-160pcs	48	
N-UD 45 33	45	33	6	8	40-55pcs	100	
N-UD 45 45		45	6	8	60-70pcs	80	
N-UD 50 25	50	25	6	8	20-25pcs	100	
N-UD 50 35		35	6	8	40-60pcs	100	
N-UD 50 45		45	6	8	70-80pcs	80	
N-UD 50 50		50	6	8	80-90pcs	80	
N-UD 50 55		55	6	8	90-100pcs	48	
N-UD 50 60		60	6	8	100-120pcs	48	
N-UD 50 80		80	6	8	160-180pcs	48	
N-UD 60 25	60	25	8	10	40-45pcs	80	
N-UD 60 40		40	8	10	100-115pcs	64	
N-UD 60 50		50	8	10	100-120pcs	48	
N-UD 60 55		55	8	10	115-125pcs	48	
N-UD 60 60		60	8	10	120-135pcs	48	
N-UD 60 80		80	8	10	180-210pcs	36	
N-UD 65 33	65	33	8	10	40-75pcs	80	
N-UD 65 45		45	8	10	110-120pcs	80	
N-UD 65 65		65	8	10	180-200pcs	48	
N-UD 80 25	80	25	8	10	100-120pcs	60	
N-UD 80 30		30	8	10	110-130pcs	60	
N-UD 80 35		35	8	10	110-130pcs	60	
N-UD 80 40		40	8	10	140-160pcs	48	
N-UD 80 45		45	8	10	140-165pcs	48	
N-UD 80 50		50	8	10	160-180pcs	48	
N-UD 80 60		60	8	10	180-210pcs	36	
N-UD 80 80		80	8	10	240-290pcs	36	
N-UD 80 100		100	8	10	260-350pcs	24	
N-UD 80 120		120	8	10	280-380pcs	24	
N-UD 100 33		100	33	10	10	130-165pcs	48
N-UD 100 35			35	10	10	130-165pcs	48
N-UD 100 40	40		10	10	130-175pcs	48	
N-UD 100 50	50		10	10	220-250pcs	48	
N-UD 100 60	60		10	10	240-290pcs	32	
N-UD 100 80	80		10	10	260-350pcs	24	
N-UD 100 100	100	10	10	300-400pcs	24		
N-UD 100 120	120	10	10	380-480pcs	24		
N-UD 130 100	130	100	10	10	420-600pcs	16	
N-UD 140 35	140	35	10	10	230-300pcs	24	
N-UD 150 100	150	100	10	10	450-650pcs	16	

Product updates can be found on the website data

N-VD

N-VD Non-slip UL wire
(Open fine-tooth type)

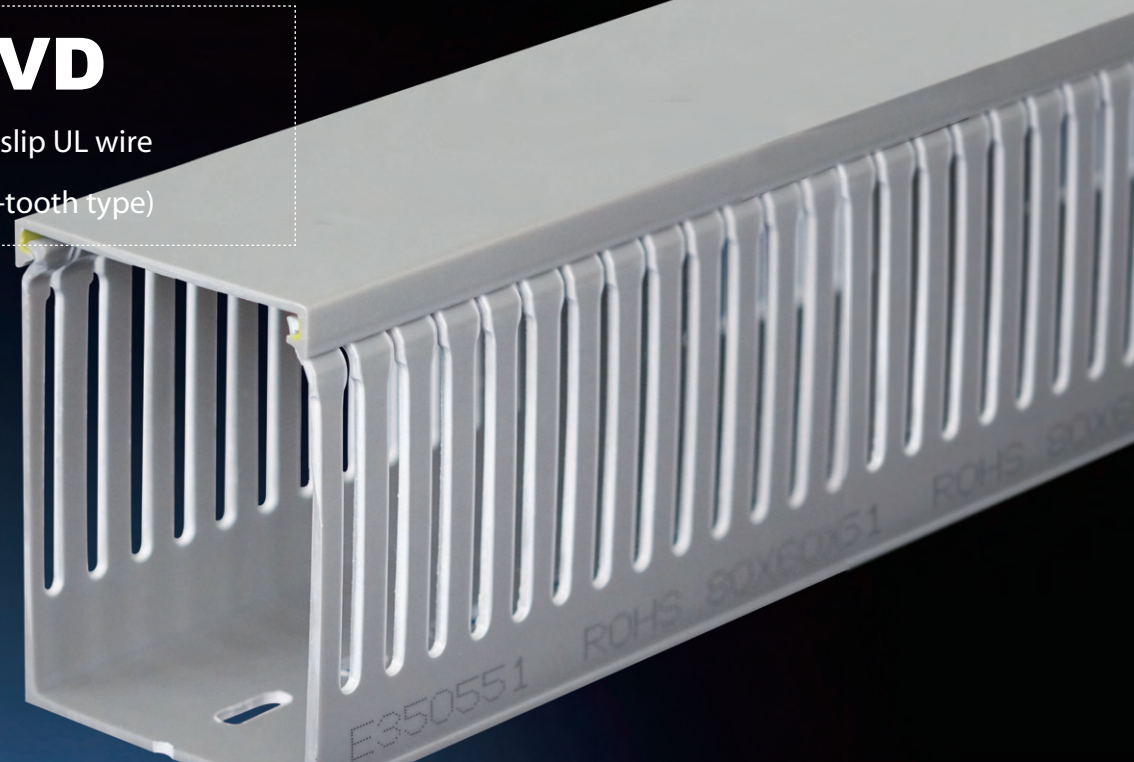

Description

- Material**
 Made from environmentally friendly and high-quality rigid PVC. The sub-slip material features coextrusion, and the interior adopts high elasticity. It's RoHS compliant.
- Flammability rating**
 UL94V-0, good self-extinguishing, good insulation properties.
- Construction**
 1. The inner side of the cover plate is designed with co-extruded non-slip strips, which is easy to install, does not fall off at any angle, and has a width greater than or equal to 40.
 2. The hole design placement is strategic to ensure easy installation and cable routing. .
- Color**
 Available Colours are (Grey, White, Blue, and Black), which can be customized.
- Temperature**
 -20°C~65°C

N-VD Non-slip UL wire (Open fine-tooth type)

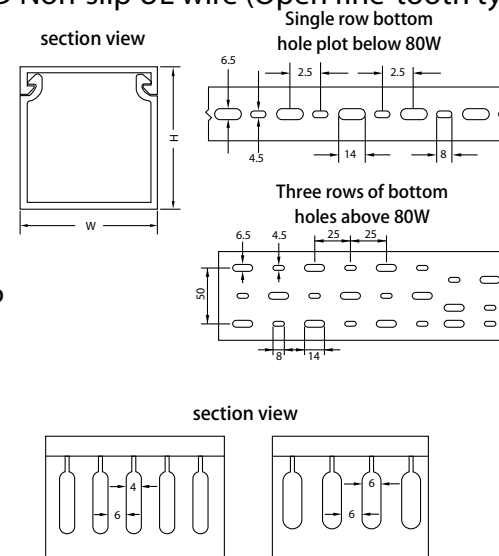

Width 40 and above are all with anti-skid strips, except 45W

N-VD Non-slip UL wire (Open fine-tooth type)

Type	mm		Slot Width mm	Sliver Width mm	Wires to be Contained Line capacity (in 2.0 square meters)	Packing M	
	H	W					
N-VD 25 25	25	25	4	6	10-25pcs	100	
N-VD 30 20	30	20	4	6	15-25pcs	100	
N-VD 30 25		25	4	6	15-25pcs	100	
N-VD 35 35	35	35	4	6	35-50pcs	100	
N-VD 40 25	40	25	4	6	20-25pcs	100	
N-VD 40 40		40	4	6	60-70pcs	100	
N-VD 40 60		60	4	6	100-115pcs	64	
N-VD 40 80		80	4	6	140-160pcs	48	
N-VD 50 25	50	25	4	6	20-25pcs	100	
N-VD 50 35		35	4	6	40-60pcs	100	
N-VD 50 45		45	4	6	70-80pcs	80	
N-VD 50 50		50	4	6	80-90pcs	80	
N-VD 50 55		55	4	6	90-100pcs	64	
N-VD 50 60		60	4	6	100-120pcs	64	
N-VD 50 80		80	4	6	160-180pcs	48	
N-VD 60 25		60	25	4	6	40-45pcs	80
N-VD 60 40	40		4	6	100-115pcs	64	
N-VD 60 50	50		4	6	100-120pcs	64	
N-VD 60 55	55		4	6	115-125pcs	48	
N-VD 60 60	60		4	6	120-135pcs	48	
N-VD 60 80	80		4	6	180-210pcs	36	
N-VD 65 33	65		33	4	6	40-75pcs	80
N-VD 65 45			45	4	6	110-120pcs	80
N-VD 65 65		65	4	6	180-200pcs	48	
N-VD 80 25	80	25	4	6	100-120pcs	60	
N-VD 80 30		30	4	6	110-130pcs	60	
N-VD 80 35		35	4	6	110-130pcs	60	
N-VD 80 40		40	4	6	140-160pcs	48	
N-VD 80 45		45	4	6	140-165pcs	48	
N-VD 80 50		50	4	6	160-180pcs	48	
N-VD 80 60		60	4	6	180-210pcs	36	
N-VD 80 80		80	4	6	240-290pcs	36	
N-VD 80 100		100	4	6	260-350pcs	24	
N-VD 80 120		120	4	6	280-380pcs	24	
N-VD 100 25		100	25	4	6	120-150pcs	48
N-VD 100 33			33	6	6	130-165pcs	48
N-VD 100 35	35		6	6	130-165pcs	48	
N-VD 100 40	40		6	6	130-175pcs	48	
N-VD 100 50	50		6	6	220-250pcs	48	
N-VD 100 60	60		6	6	240-290pcs	32	
N-VD 100 80	80		6	6	260-350pcs	24	
N-VD 100 100	100		6	6	300-400pcs	24	
N-VD 100 120	120		6	6	380-480pcs	24	

Product updates can be found on the website data

N-OFD

N-OFD Non-slip UL wiring duct
(Square closed type)

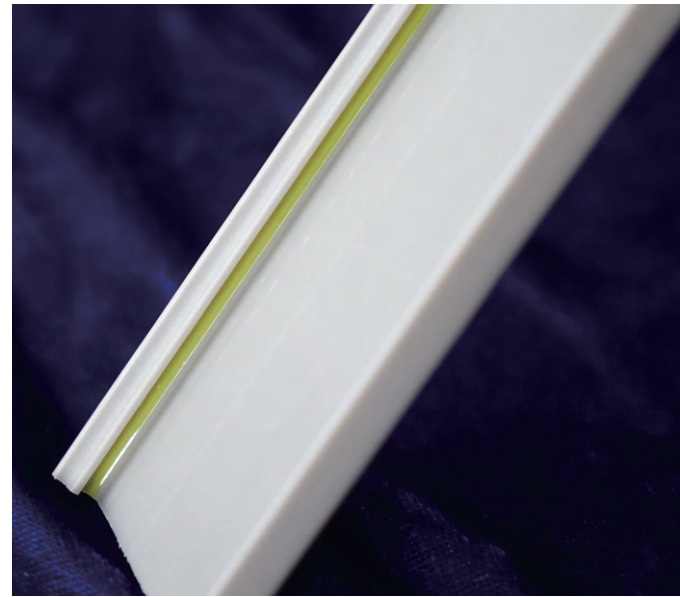

section view

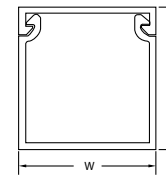

Single row bottom hole plot below 80W

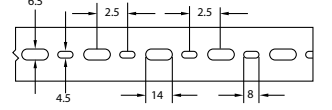

Three rows of bottom holes above 80W

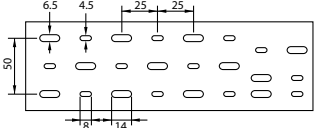

section view

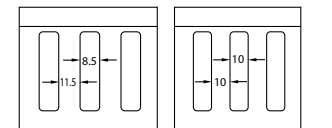

N-OFD Non-slip UL wiring duct (Square closed type)

Width 40 and above are all with anti-skid strips, except 45W

Type	mm		Slot Width mm	Sliver Width mm	Wires to be Contained Line capacity (in 2.0 square meters)	Packing M
	H	W				
N-OFD 40 25	40	25	8.5	11.5	20-25pcs	100
N-OFD 40 40		40	8.5	11.5	60-70pcs	100
N-OFD 40 60		60	8.5	11.5	100-115pcs	64
N-OFD 40 80		80	8.5	11.5	140-160pcs	48
N-OFD 50 25	50	25	10	10	20-25pcs	100
N-OFD 50 35		35	10	10	40-60pcs	100
N-OFD 50 45		45	10	10	70-80pcs	80
N-OFD 50 50		50	10	10	80-90pcs	80
N-OFD 50 55		55	10	10	90-100pcs	48
N-OFD 50 60		60	10	10	100-120pcs	48
N-OFD 50 80	60	80	10	10	160-180pcs	48
N-OFD 60 25		25	8.5	11.5	40-45pcs	80
N-OFD 60 40		40	8.5	11.5	100-115pcs	64
N-OFD 60 50		50	8.5	11.5	100-120pcs	48
N-OFD 60 55		55	8.5	11.5	115-125pcs	48
N-OFD 60 60		60	8.5	11.5	120-135pcs	48
N-OFD 60 80	80	80	8.5	11.5	180-210pcs	36
N-OFD 80 25		25	10	10	100-120pcs	60
N-OFD 80 30		30	10	10	110-130pcs	60
N-OFD 80 35		35	10	10	110-130pcs	60
N-OFD 80 40		40	10	10	140-160pcs	48
N-OFD 80 45		45	10	10	140-165pcs	48
N-OFD 80 50		50	10	10	160-180pcs	48
N-OFD 80 60		60	10	10	180-210pcs	36
N-OFD 80 80		80	10	10	240-290pcs	36
N-OFD 80 100		100	10	10	260-350pcs	24
N-OFD 80 120		120	10	10	280-380pcs	24

Product updates can be found on the website data

Description

Material

Made from environmentally friendly and high-quality rigid PVC. The sub-slip material is co-extruded, and the interior adopts high elasticity. It's RoHS compliant.

Flammability rating

UL94V-0, good self-extinguishing ability, and good insulation properties.

Construction

1. The inner side of the cover plate is designed with co-extruded non-slip strips, which is easy to install, does not fall off at any angle, and has a width greater than or equal to 40.

2. The hole design placement is strategic to ensure easy installation and cable routing.

Color

Available Colours are (Grey, White, Blue, and Black), which can be customized

Temperature

-20°C~65°C

N-UFD/VFD

N-UFD/VFD Non-slip UL wiring duct
(Double partition tooth type)



N-UFD Non-slip UL wiring duct (Double partition tooth type)

Type	mm		Slot Width mm	Sliver Width mm	Wires to be Contained Line capacity (in 2.0 square meters)	Packing M	
	H	W					
N-UFD 80 25	80	25	8	10	100-120pcs	60	
N-UFD 80 30		30	8	10	110-130pcs	60	
N-UFD 80 35		35	8	10	110-130pcs	60	
N-UFD 80 40		40	8	10	140-160pcs	48	
N-UFD 80 45		45	8	10	140-165pcs	48	
N-UFD 80 50		50	8	10	160-180pcs	48	
N-UFD 80 60		60	8	10	180-210pcs	36	
N-UFD 80 80		80	8	10	240-290pcs	36	
N-UFD 80 100		100	8	10	260-350pcs	24	
N-UFD 80 120		120	8	10	280-380pcs	24	
N-UFD 100 25		100	25	8	12	120-150pcs	48
N-UFD 100 33			33	8	12	130-165pcs	48
N-UFD 100 35	35		8	12	130-165pcs	48	
N-UFD 100 40	40		8	12	130-175pcs	48	
N-UFD 100 50	50		8	12	220-250pcs	48	
N-UFD 100 60	60		8	12	240-290pcs	32	
N-UFD 100 80	80		8	12	260-350pcs	24	
N-UFD 100 100	100		8	12	300-400pcs	24	
N-UFD 100 120	120		8	12	380-480pcs	24	

Product updates can be found on the website data

Description

Material

Made from environmentally friendly and high-quality rigid PVC. The sub-slip material is co-extruded, and the interior adopts high elasticity. It's RoHS compliant

Flammability rating

UL94V-0, good self-extinguishing ability, and good insulation properties.

Construction

- The inner side of the cover plate is designed with co-extruded non-slip strips, which is easy to install, does not fall off at any angle, and has a width greater than or equal to 40.
- The hole design placement is strategic to ensure easy installation and cable routing.

Color

Available Colours are (Grey, White, Blue, and Black), which can be customized

Temperature

-20°C~65°C

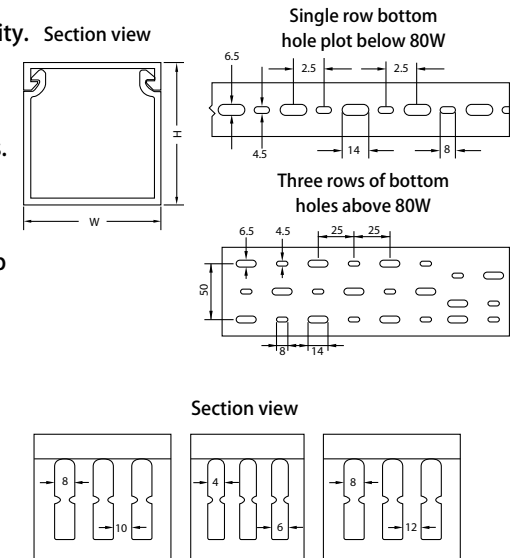

Width 40 and above are all with anti-skid strips, except 45W

N-VFD Non-slip UL wiring duct (Double partition tooth type)

Type	mm		Slot Width mm	Sliver Width mm	Wires to be Contained Line capacity (in 2.0 square meters)	Packing M	
	H	W					
N-VFD 80 25	80	25	4	6	100-120pcs	60	
N-VFD 80 30		30	4	6	110-130pcs	60	
N-VFD 80 35		35	4	6	110-130pcs	60	
N-VFD 80 40		40	4	6	140-160pcs	48	
N-VFD 80 45		45	4	6	140-165pcs	48	
N-VFD 80 50		50	4	6	160-180pcs	48	
N-VFD 80 60		60	4	6	180-210pcs	36	
N-VFD 80 80		80	4	6	240-290pcs	36	
N-VFD 80 100		100	4	6	260-350pcs	24	
N-VFD 80 120		120	4	6	280-380pcs	24	
N-VFC 100 25		100	25	4	6	120-150pcs	48
N-VFC 100 33			33	4	6	130-165pcs	48
N-VFC 100 35	35		4	6	130-165pcs	48	
N-VFC 100 40	40		4	6	130-175pcs	48	
N-VFC 100 50	50		4	6	220-250pcs	48	
N-VFC 100 60	60		4	6	240-290pcs	32	
N-VFC 100 80	80		4	6	260-350pcs	24	
N-VFC 100 100	100		4	6	300-400pcs	24	
N-VFC 100 120	120		4	6	380-480pcs	24	

Product updates can be found on the website data

N-MD

N-MD Non-slip UL wiring duct
(Totally enclosed type)



N-MD Non-slip UL wiring duct (Totally enclosed type)

Type	mm		Wires to be Contained Line capacity (in 2.0 square meters)	Packing M
	H	W		
N-MD 40 25	40	25	20-25pcs	100
N-MD 40 40		40	60-70pcs	100
N-MD 40 60		60	100-115pcs	64
N-MD 40 80		80	140-160pcs	48
N-MD 45 33	45	33	40-55pcs	100
N-MD 45 45		45	60-70pcs	80
N-MD 50 25	50	25	20-25pcs	100
N-MD 50 35		35	40-60pcs	100
N-MD 50 45		45	70-80pcs	80
N-MD 50 50		50	80-90pcs	80
N-MD 50 55		55	90-100pcs	48
N-MD 50 60		60	100-120pcs	48
N-MD 50 80		80	160-180pcs	48
N-MD 60 25	60	25	40-45pcs	80
N-MD 60 40		40	100-115pcs	64
N-MD 60 50		50	100-120pcs	48
N-MD 60 55		55	115-125pcs	48
N-MD 60 60		60	120-135pcs	48
N-MD 60 80		80	180-210pcs	36
N-MD 65 33	65	33	40-75pcs	80
N-MD 65 45		45	110-120pcs	80
N-MD 65 65		65	180-200pcs	48
N-MD 80 25	80	25	100-120pcs	60
N-MD 80 30		30	110-130pcs	60
N-MD 80 35		35	110-130pcs	60
N-MD 80 40		40	140-160pcs	48
N-MD 80 45		45	140-165pcs	48
N-MD 80 50		50	160-180pcs	48
N-MD 80 60		60	180-210pcs	36
N-MD 80 80		80	240-290pcs	36
N-MD 80 100		100	260-350pcs	24
N-MD 80 120		120	280-380pcs	24
N-MD 100 33	100	33	130-165pcs	48
N-MD 100 35		35	130-165pcs	48
N-MD 100 40		40	130-175pcs	48
N-MD 100 50		50	220-250pcs	48
N-MD 100 60		60	240-290pcs	32
N-MD 100 80		80	260-350pcs	24
N-MD 100 100	100	300-400pcs	24	
N-MD 100 120	120	380-480pcs	24	
N-MD 120 75	120	75	280-380pcs	24
N-MD 130 100	130	100	420-600pcs	16
N-MD 140 35	140	35	230-300pcs	24
N-MD 150 100	150	100	450-650pcs	16

Description

- Material**
Made from environmentally friendly and high-quality rigid PVC. The sub-slip material is co-extruded, and the interior adopts high elasticity. It's RoHS compliant
- Flammability rating**
UL94V-0, good self-extinguishing, good insulation properties.
- Construction**
 - The inner side of the cover is designed with co-extruded non-slip strips, which is easy to install and does not fall off at any angle.
 - The sealed wire groove features high strength and is specially designed to be dust and rodent proof.
- Color**
Available Colours are (Grey, White, Blue, and Black), which can be customized.
- Temperature**
-20°C~65°C

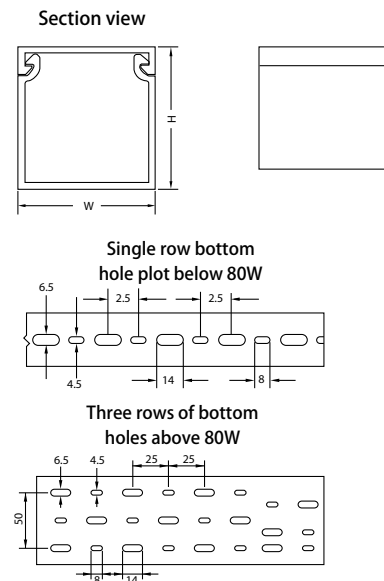

Width 40 and above are all with anti-skid strips, except 45W

Product updates can be found on the website data



YIFENG NEW MATERIALS



Low smoke zero halogen.

SWD-KB Standard duct cover. L/R-KB comes with a low-smoke halogen-free cover.
L-KB low-smoke halogen-free cover /N-KB UL non-slip wiring duct cover
DS flexible Dragon bone wire groove / FD series dial wire groove
Wiring duct tools / cable fixing folder



SWD-KB

Standard wiring duct cover

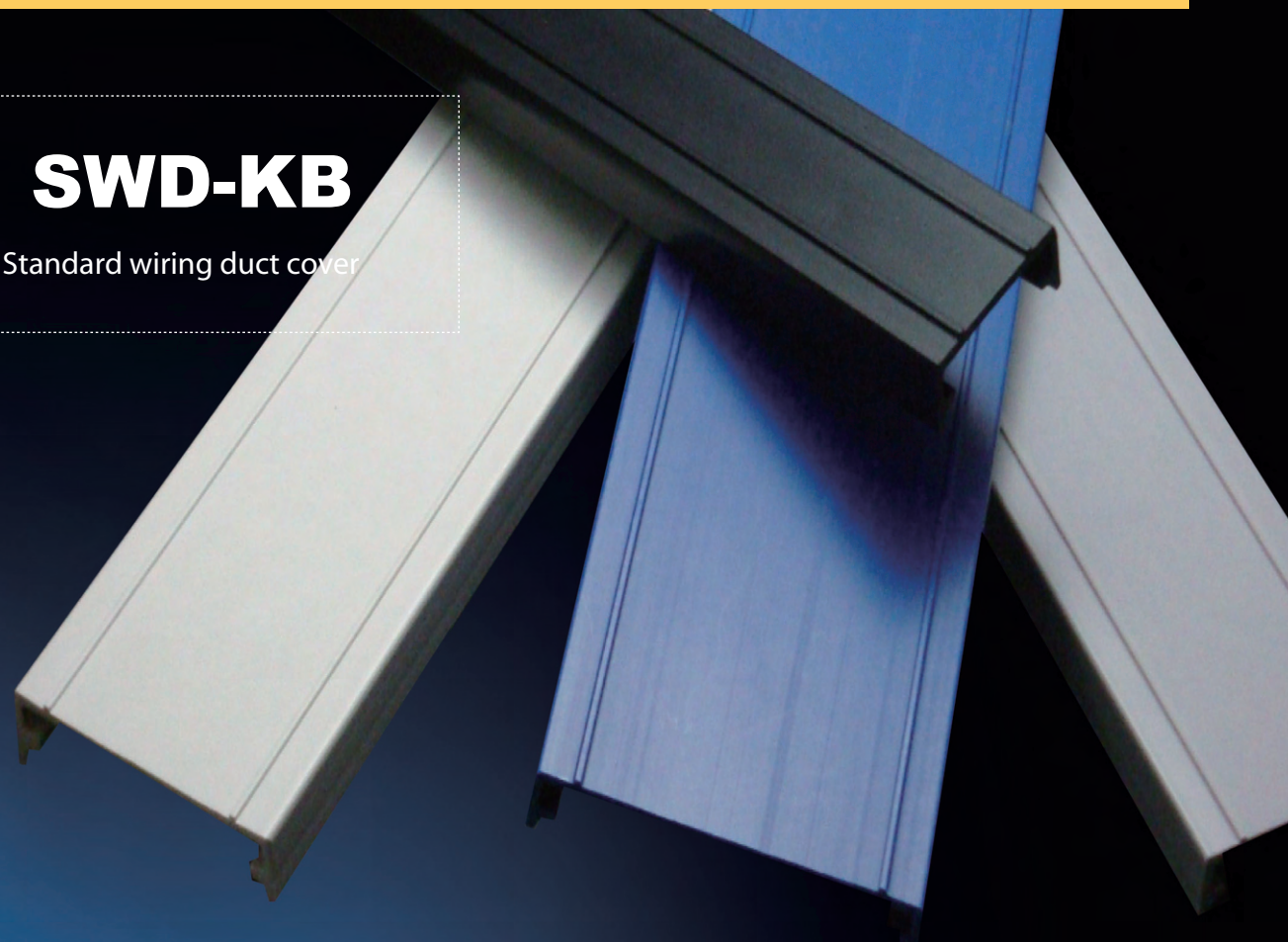

Description

- Material**
 Made from high quality rigid, low smoke PVC, which is ROHS compliant.
- Flammability rating**
 UL94 V-0 flame retardant grade, good self-extinguishing ability, and good insulation properties.
- Construction**
 Features a base and cover, Easy, firm, snap on assembly, and smooth joining for a better finish.
- Color**
 Available Colours are (Grey, White, Blue, and Black), which can be customized.
- Temperature**
 -20°C~65°C

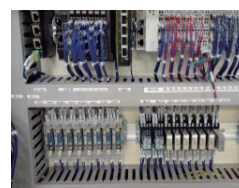
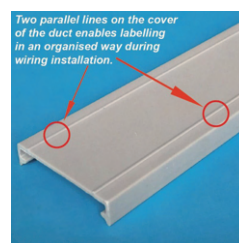

Type	Width mm
SWD-KB 20	20
SWD-KB 25	25
SWD-KB 33	33
SWD-KB 35	35
SWD-KB 40	40
SWD-KB 45	45
SWD-KB 50	50
SWD-KB 55	55
SWD-KB 60	60
SWD-KB 65	65
SWD-KB 80	80
SWD-KB 100	100
SWD-KB 120	120
SWD-KB 140	140

Product updates can be found on the website data

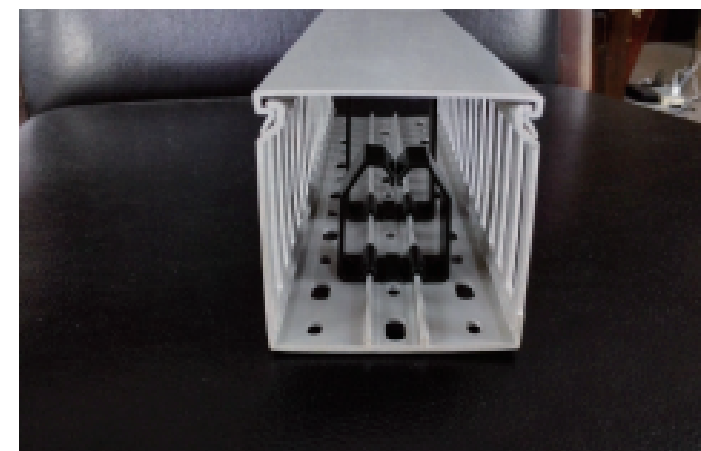
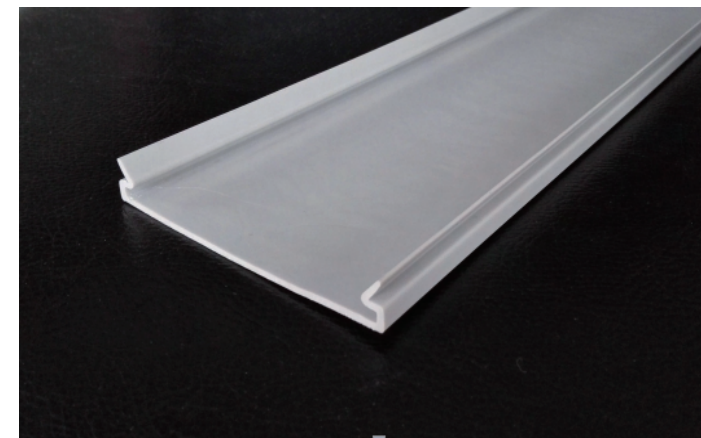

L/R-KB Reinforced

Type	Width mm
L/R-KB 25	25
L/R-KB 35	35
L/R-KB 37.5	37.5
L/R-KB 50	50
L/R-KB 75	75
L/R-KB 100	100

Product updates can be found on the website data

Description

- Material**
 Made from PC+ABS, halogen free, Low smoke, RoHS compliant, Insulating material. Designed for better fire and electrical safety.
- Flammability rating**
 UL94V-0, non-flame propagation.
- Construction**
 Features a double layered structure cover design that snaps on well and easy to install.
- Color**
 Grey RAL 7035
- Temperature**
 -40°C~90°C
- Compliance**
 Complies with EN 45545, DIN 5510-2

L-KB

Low-smoke halogen-free

wiring duct cover



Description

- Material**
Made from PC+ABS, halogen free, Low smoke, RoHS compliant, Insulating material. Designed for better fire and electrical safety.
- Flammability rating**
UL94V-0, flame restriction product.
- Construction**
Features a special mark line design on the cover which allows a quick tag of relevant components.
- Color**
Grey RAL 7035
- Compliance**
Complies with EN 45545, DIN 5510-2
- Temperature**
-40°C~90°C

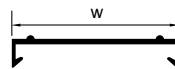

Type	Width mm
L-KB 25	25
L-KB 30	30
L-KB 35	35
L-KB 40	40
L-KB 45	45
L-KB 50	50
L-KB 60	60
L-KB 75	75
L-KB 80	80
L-KB 100	100
L-KB 120	120

Product updates can be found on the website data



Width 40 and above are all with anti-skid strips, except 45W

N-KB UL non-slip wiring duct cover

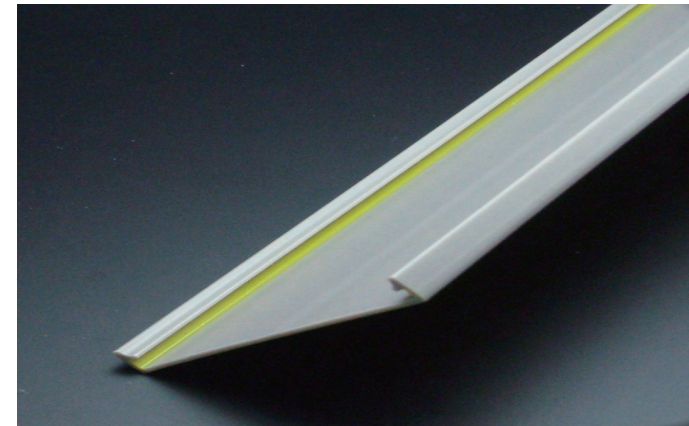
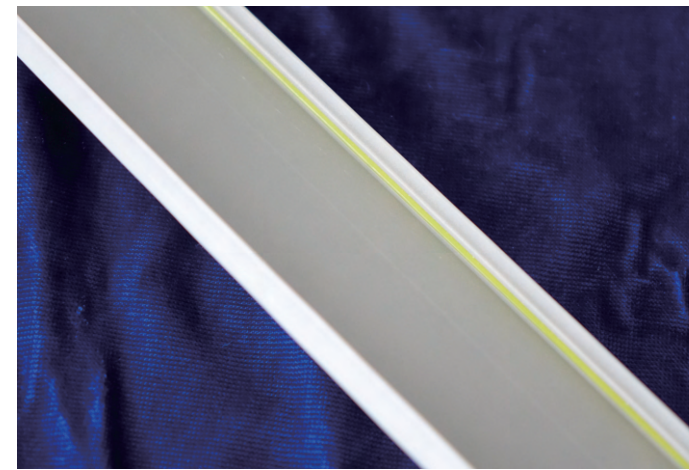

Type	Width mm
N-KB 25	25
N-KB 33	33
N-KB 35	35
N-KB 40	40
N-KB 45	45
N-KB 50	50
N-KB 60	60
N-KB 65	65
N-KB 75	75
N-KB 80	80
N-KB 100	100
N-KB 120	120

Product updates can be found on the website data

Description

- Material**
Made from High quality rigid PVC, which is RoHS compliant.
- Flammability rating**
UL94V-0, good self-extinguishing and insulation properties.
- Construction**
The inner side of the cover is designed with co-extruded non-slip strips, which is easy to install and does not fall off at any angle.
- Color**
Available Colours are (Grey, White, Blue, and Black), which can be customized.
- Temperature**
-20°C~65°C

DS Flexible Duct

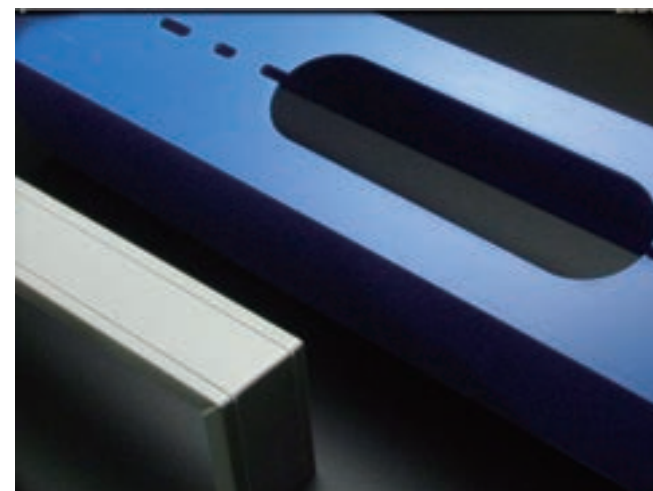
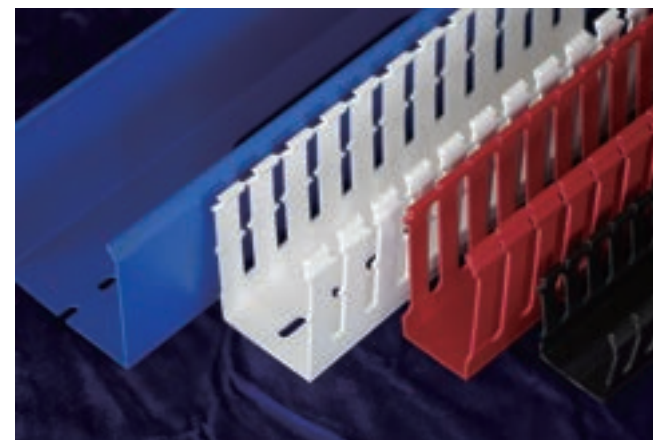

Special customized products

- 1. Batch length customization
- 2. Special large bottom hole customization size: 30*130
Size: 40*1403.
- 3. Right-angle bending of cover plate customization
- 4. Special color customization {Only for PVC material}



Description

■ **Material**
Environmentally friendly flame-retardant PP

Flame retardant grade: UL94-V0

With adhesive backing, it can be flexibly bent. It is suitable for connection between cabinet cables and cabinet doors.



Type	Size mm		
	W	H	L
DS-20	17	25	500
DS-30	30	40	500

Product updates can be found on the website data

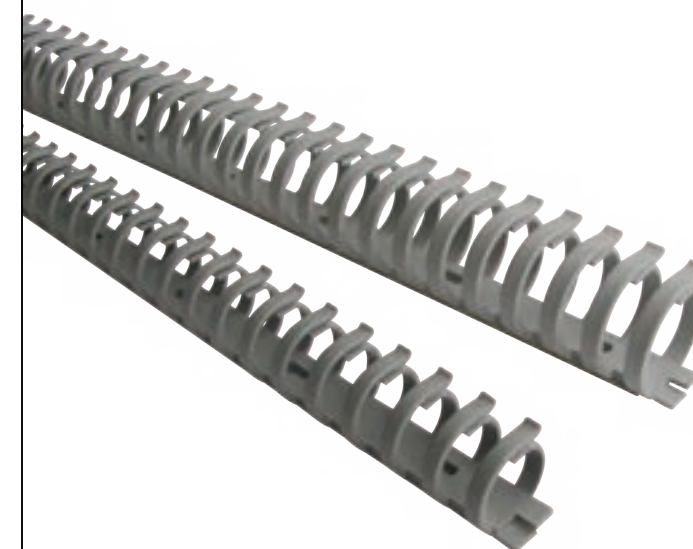

FD series pull open duct

Description

■ **Material**
NYLON 66 (GY)
With adhesive backing, it is suitable for installation in cabinet doors or places with small gaps, and can be connected and extended

Type	Size mm		
	W	H	L
FD-20	20.4	14.4	500
FD-30	29	24.9	500
FD-40	39	36	500

Product updates can be found on the website data

Wiring Duct Cutter



YWT-1

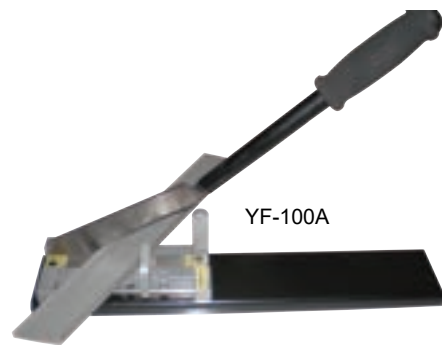

YF-100A

Item No.	Name	Length	Applicable product width
YWT-1	Wire slot cutter	knife length 65mm	60mm <
YF-100A	Wireway Cutter	knife length 115mm	80mm <
MTS-01	Multifunctional wire slot cutter	knife length 60mm	60mm Below, the outlet hole is cut

Product updates can be found on the website data



MTS-01 is specially used for cutting PC+ABS alloy materials, and the curved blade tip is used for scribing the cutting edge

Item No.	Name
WSP-60	WIER SLOT PLIER WIER SLOT PLIER

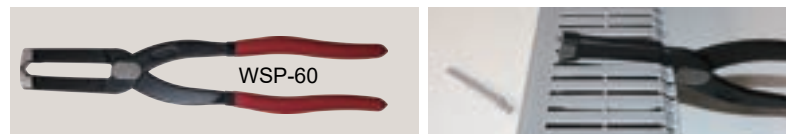

WSP-60

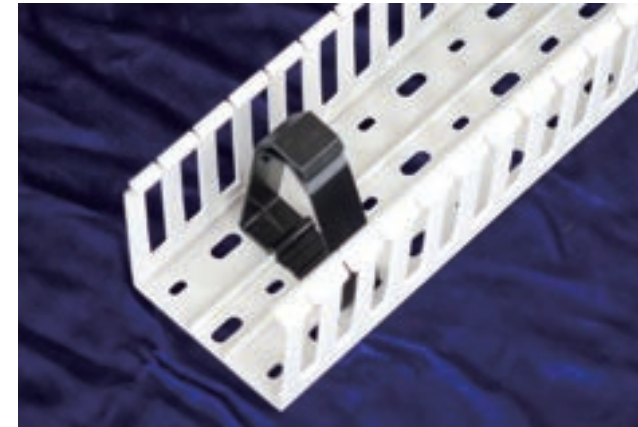

Wiring Retainer

Description

■ **Materials**
Environmentally friendly
flame-retardant, PP Fire rating: V-0

■ **Color**
Black. Red. Green

■ **Construction**

The wire harness can be easily installed on the track, at the bottom of the wire groove, it can slide freely, and can be placed at the position of the wire outlet, which allows wire to be neatly arranged vertically. The upper part of the wire clip can be buckled to keep the wires in place. It's designed to reduce the space occupied by the main accessory body.

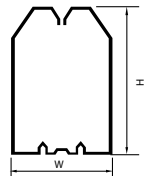

Item No.	Size mm (HxW)	Packing M
RT-4040	40*40	100PCS
RT-6840	68*40	
RT-6865	68*65	

Product updates can be found on the website data

Wireless clip cabling



Use the clip effect



LSZH

filter with draining and heat radiation functions (externally mounted)

IP55



LSZH Fans & Filters

Description

Made from PC+ABS macromolecule materials which is low smoke, halogen free, environment friendly, flame retarding. It is customized for high-speed trains, rail transits, ships, nuclear powers, new energies etc. It boasts a patented design, and IP protection up to IP55, all these designs offer high protection against high heat and radiation.

- 1. Features a hinge system for improves handling efficiency, filter mat easy install and replacement. (Figure 1)
- 2. Features a class IP55 protection (Figure 2b)
- 3. Features non-screws fastening (Figure 3)
- 4. Features an energy saving ventilation function (Figure 4)

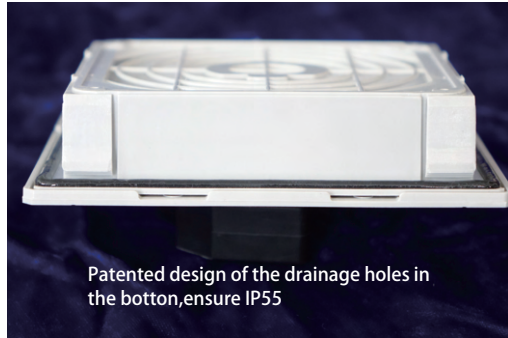

Patented design of the drainage holes in the bottom,ensure IP55

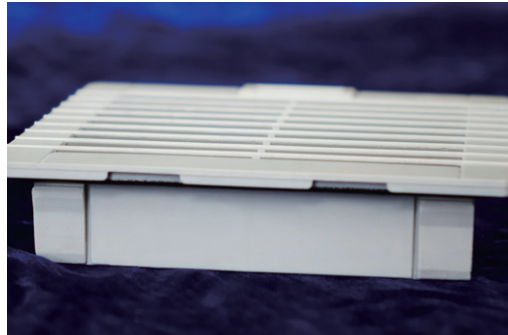

Y Series Filters

YIFENG
NEW MATERIALS
IP55

109x109mm

- 1. 4-corner latching, fastening without screws.
- 2. Patented hinges system for simplest possible handing, easily inserl filter mat.
- 3. Pouring seal.
- 4. System of protection IP55.

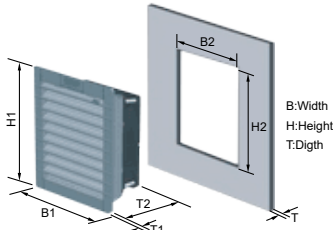

Ventilator Fitter

Type	Part Number	IP	Filtration efficiency	Sizes(mm)				Operation temperature	Weight	Color
				B1/H1	B2/H2	T1	T2			
YVF 112	YVF 112H	IP55	91%	109	92°	4	20	-30~70 °C	60g	RAL7035
Attachment filter mat										
Type	Part Number	IP								
YFM 112	YFM 112H	IP55								

Note: +1mmB2/H2, T>2mm≤3mm

Fan Fitter

Type	Part Number	IP	Bearing System	Rating Voltage (VAC)	Frequency (Hz)	Electrical parameters					
						Current (A)	Input power (W)	Noice Level dB(A)	Air flow (CFM)	Depth T2(mm)	Weight (g)
YFF 112	112H8025HA2*BL	IP55	B/S	230°	50/60	0.070/0.06	14.0/13.5	29/33	9/11	50	300
	112H9225HA2*BT		B/S			0.07/0.06	14.0/13.5	32/37	15/19	50.5	310
	112H8038HA2*BT		B/S			0.11/0.10	18.0/16.0	31/35	12/16	63	410
	112H9238HA2*BT		B/S			0.12/0.11	16.0/14.0	32/36	22/25	63.5	420

Note: *= "S" or "B" (S for siceve bearing, B for bail bearings).
①Suiled 110VAC or 380VAC product, customized other.
Product updates can be found on the website data



L SZH Fans & Filters

Y Series Filters

145x145mm

- 1. Features a 4-corner latching and non-screws fastening.
- 2. Features a hinge system for improves handling efficiency, filter mat easy install and replacement
- 3. Features flexible seals
- 4. Features a class IP55 protection

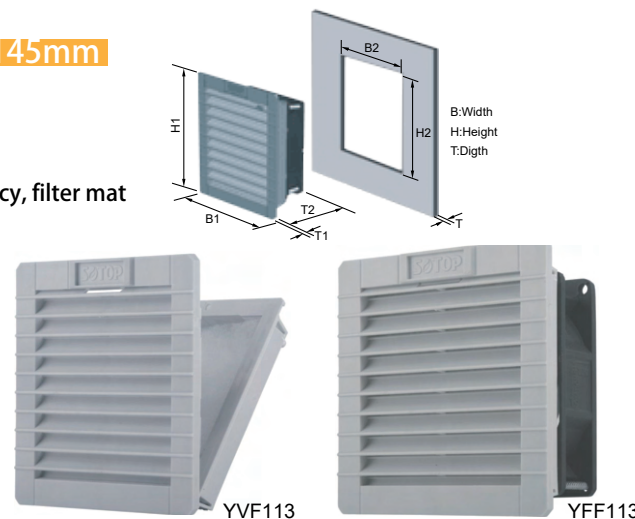

Ventilator Fitter

Type	Part Number	IP	Filtration efficiency	Sizes(mm)				Operation temperature	Weight	Color
				B1/H1	B2/H2	T1	T2			
YVF 113	YVF 113H	IP55	91%	145	124°	5	28	-30~70 C	120g	RAL7035
Attachment filter mat										
Type	Part Number	IP								
YFM 113	YFM 113H	IP55								

Note: +1mmB2/H2, T>2mm≤3mm

Fan Fitter

Type	Part Number	IP	Bearing System	Rating Voltage (VAC)	Electrical parameters							Depth T2(mm)	Weight (g)
					Frequency (Hz)	Current (A)	Input power (W)	Noice Level dB(A)	Air flow (CFM)				
YFF113	113H1225HA2*PT	IP55	B/S	230°	50/60	0.08/0.09	19.0/18.0	38/40	36/43	62	420		
	113H1238HA2*MT		B/S			0.12/0.10	17/15	42/47	54/66	75	620		

Note: *= "S" or "B" (S for siceve bearing, B for bail bearings).

①Suiled 110VAC or 380VAC product, customized other.

Product updates can be found on the website data

Y Series Filters

202x202mm

- 1. Features a 4-corner latching and non-screws fastening.
- 2. Features a hinge system for improves handling efficiency, filter mat easy install and replacement
- 3. Features flexible seals
- 4. Features a class IP55 protection

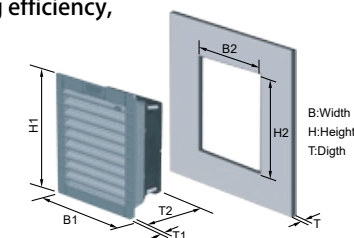

Ventilator Fitter

Type	Part Number	IP	Filtration efficiency	Sizes(mm)				Operation temperature	Weight	Color
				B1/H1	B2/H2	T1	T2			
YVF 114	YVF 114H	IP55	91%	202	177°	6	36	-30~70 C	260g	RAL7035
Attachment filter mat										
Type	Part Number	IP								
YFM 114	YFM 114H	IP55								

Note: +1mmB2/H2, T>2mm≤3mm

Fan Fitter

Type	Part Number	IP	Bearing System	Rating Voltage (VAC)	Electrical parameters							Depth T2(mm)	Weight (g)
					Frequency (Hz)	Current (A)	Input power (W)	Noice Level dB(A)	Air flow (CFM)				
YFF 114	114H1255HA2*PT	IP55	B/S	230°	50/60	0.09/0.09	19.0/18.0	38/40	42/50	79	560		
	114H1238HA2*MT		B/S			0.12/0.10	17/15	42/47	63/76	92	760		
	114H1725HA2*MT		B/S			0.21/0.19	32.0/30.0	50/53	131/144	98	1190		
	114H1725HA2BMT		B/S			0.12/0.13	26/30	58/62	161/191	102	1150		

Note: *= "S" or "B" (S for siceve bearing, B for bail bearings).

①Suiled 110VAC or 380VAC product, customized other.

Product updates can be found on the website data



SZH Fans & Filters

Y Series Filters

252x252mm

- 1. Features a 4-corner latching and non-screws fastening.
- 2. Features a hinge system for improves handling efficiency, filter mat easy install and replacement
- 3. Features flexible seals
- 4. Features a class IP55 protection

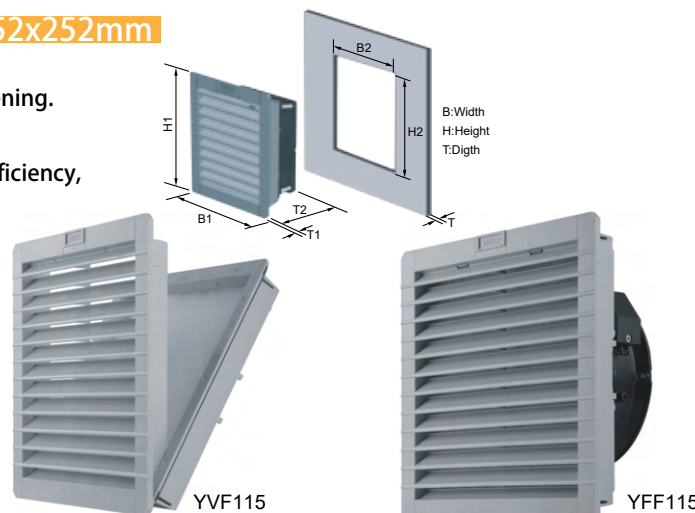

Ventilator Fitter

Type	Part Number	IP	Filtration efficiency	Sizes(mm)				Operation temperature	Weight	Color
				B1/H1	B2/H2	T1	T2			
YVF 115	YVF 115H	IP55	91%	262	224°	6	38	-30~70 C	400g	RAL7035

Attachment filter mat

Type	Part Number	IP
YFM 115	YFM 115H	IP55

Note: +1mmB2/H2, T>2mm≤3mm

Fan Fitter

Type	Part Number	IP	Bearing System	Rating Voltage (VAC)	Electrical parameters						
					Frequency (Hz)	Current (A)	Input power (W)	Noise Level dB(A)	Air flow (CFM)	Depth T2(mm)	Weight (g)
YFF 115	115H1725HA2*MT	IP55	B/S	230°	50/60	0.21/0.19	32/30	50/53	158/174	113	1330
	115H17255HA2BMT		B			0.12/0.13	26/30	58/62	196/232	117	1290
	115H1806HA2BMT		B			0.24/0.27	53/62	60/64	309/356	128	2330

Note: *= "S" or "B" (S for siceve bearing, B for bail bearings).

①Suiled 110VAC or 380VAC product, customized other.

Product updates can be found on the website data

Y Series Filters

320x320mm

- 1. Features a 4-corner latching and non-screws fastening.
- 2. Features a hinge system for improves handling efficiency, filter mat easy install and replacement
- 3. Features flexible seals
- 4. Features a class IP55 protection

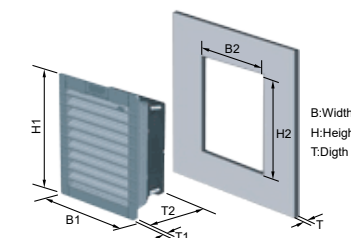

Ventilator Fitter

Type	Part Number	IP	Filtration efficiency	Sizes(mm)				Operation temperature	Weight	Color
				B1/H1	B2/H2	T1	T2			
YVF 116	YVF 116H	IP55	91%	320	292°	6	40	-30~70 C	670g	RAL7035

Attachment filter mat

Type	Part Number	IP
YFM 116	YFM 116H	IP55

Note: +1mmB2/H2, T>2mm≤3mm

Fan Fitter

Type	Part Number	IP	Bearing System	Rating Voltage (VAC)	Frequency (Hz)	Electrical parameters					
						Current (A)	Input power (W)	Noise Level dB(A)	Air flow (CFM)	Depth T2(mm)	Weight (g)
YFF 116	116H2206HA2BMT	IP55	B	230°	50/60	0.20/0.26	47/58	61/67	384/438	122	2260
	116H2208HA2BMT		B			0.22/0.30	52/68	65/68	500/518	142	2610
	116H2509HA2BMT		B			0.22/0.30	52/68	65/65	599/660	150	3150
	116H2072HA2BMT		B			0.46/0.50	97/115	69/72	875/1071	133	3120

Ventilator Filter with ir duct

Type	Part Number	IP
YFF116C	YFF 116C200H	IP55
	YFF 116C233H	

Note: ①Suiled 110VAC or 380VAC product, customized other.

Product updates can be found on the website data

Din Rails

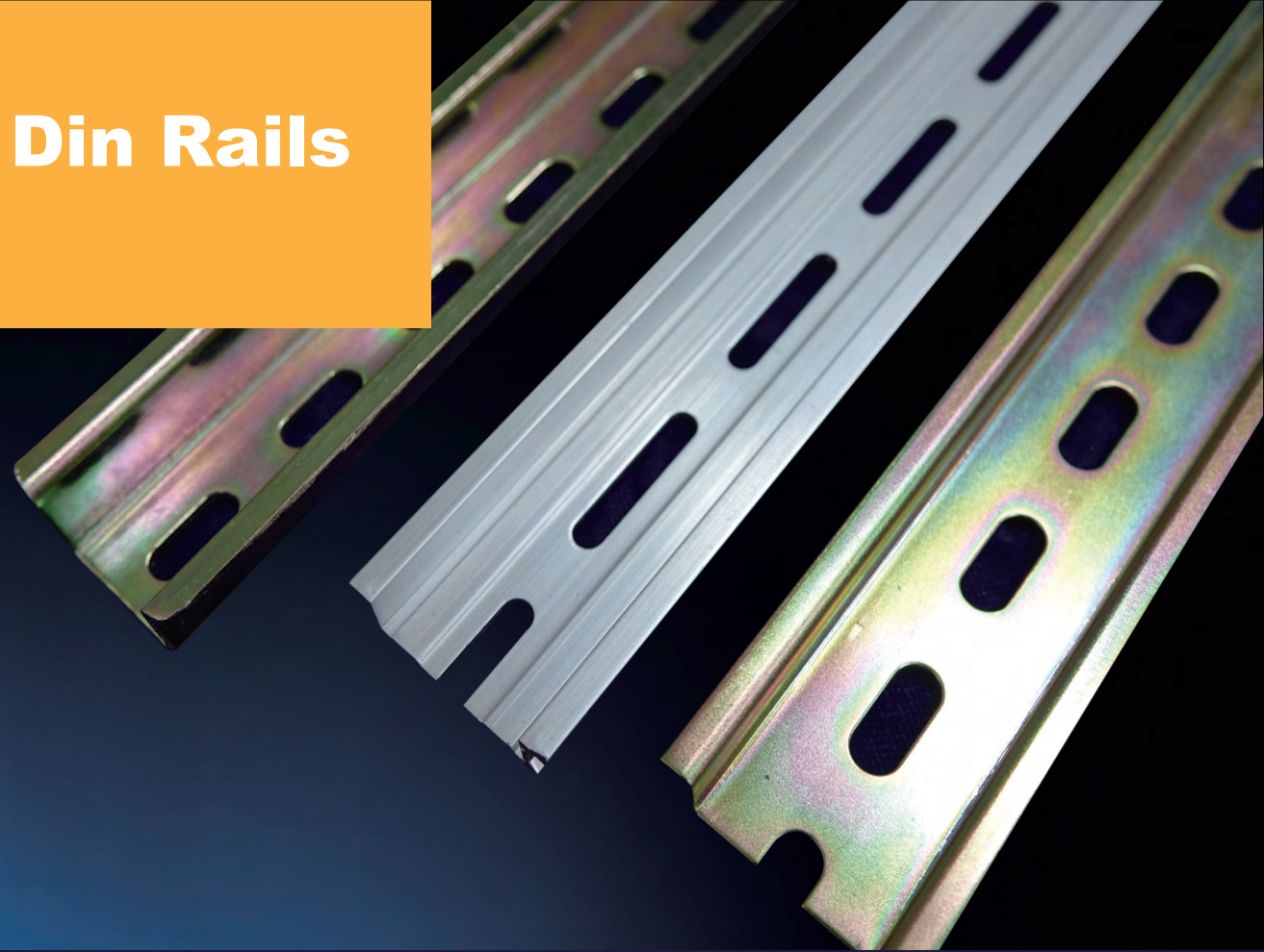

Steel DIN Rail

Item No.: SG 32/15

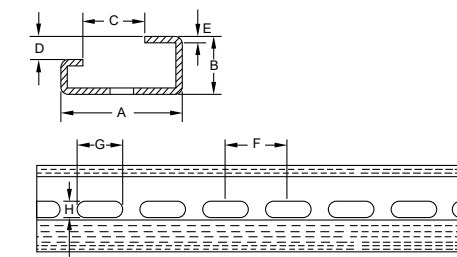
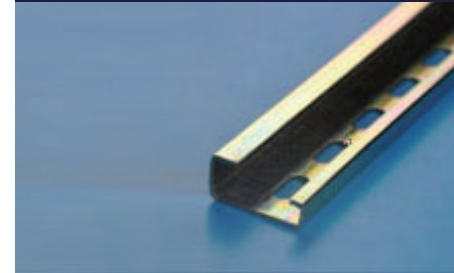

Length in
Inches(mm)

A	1.25"(32mm)
B	0.594"(15mm)
C	0.656"(16.5mm)
D	0.236"(6mm)
E	0.059"(1.5mm)
F	0.984"(25mm)
G	0.594"(15mm)
H	0.245"(6.2mm)

Item No.: SU 35/7.5

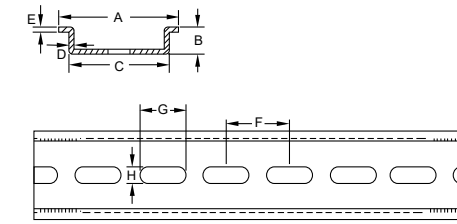
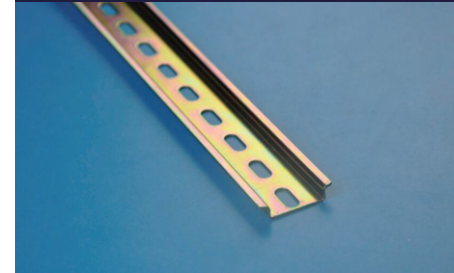

Length in
Inches(mm)

A	1.4"(35mm)
B	0.3"(7.5mm)
C	1.138"(27mm)
D	0.039"(1.0mm)
E	0.039"(1.0mm)
F	0.984"(25mm)
G	0.594"(15mm)
H	0.245"(6.2mm)

Item No.: SUT 35/15

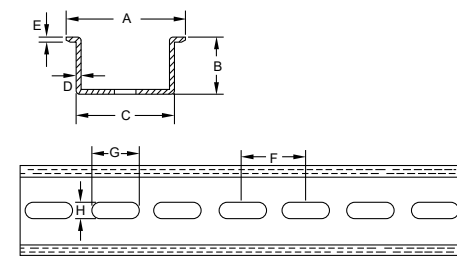

Length in
Inches(mm)

A	1.4"(35mm)
B	0.594"(15mm)
C	1.138"(27mm)
D	0.059"(1.5mm)
E	0.039"(1.0mm)
F	0.984"(25mm)
G	0.594"(15mm)
H	0.245"(6.2mm)

Item No.: SU 15/5

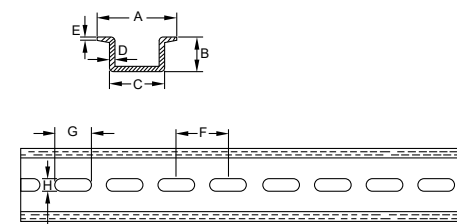

Length in
Inches(mm)

A	0.594"(15mm)
B	0.217"(5.5mm)
C	0.336"(8.5mm)
D	0.039"(1.0mm)
E	0.039"(1.0mm)
F	0.984"(25mm)
G	0.475"(12mm)
H	0.165"(4.2mm)

Din Rails

Type	Width (mm)	High (mm)	Thickness (mm)	Cavity	Length (m)	Hole length (mm)	Hole center distance (mm)	Surface treatment
AU 35/7.5-1.1(4.8-25)-1	35	7.5	1.1	U type	1	Φ4.8*25	35	oxidation
AU 35/7.5-1.1(4.8-25)-2	35	7.5	1.1	U type	2	Φ4.8*25	35	oxidation

Product updates can be found on the website data

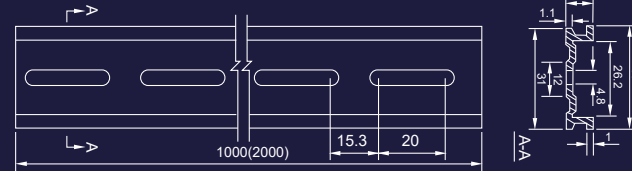
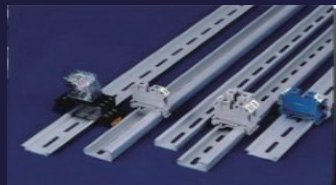

Snap-on sleeve sticky sleeve



Features buckle casing and adhesive casing which are widely used in the electronics field like, automobiles, shipbuilding, aviation, communications, automation, industrial equipment, robots, elevators, high and low voltage distribution cabinets and other fields of cable protection and finishing.



Hook & Loop Tubes

Description

- **Function**
Features cable sorting and wire protection, damage prevention from extrusion, chemical corrosion and wea. Features good insulation, aesthetics, and finishing. Wires are built to be the first line of defense against power surge, protecting equipment against accidents and safety hazards caused by wire damage.
- **Thickness: 0.35mm** ■ **Color: Black/Gray**

- **Material:**
PVC Double-layered fabric + Nylon Adhesive cover

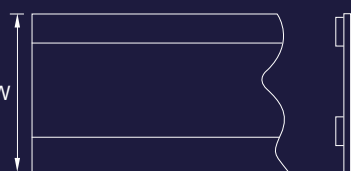

Type	Band Width (mm)	Max Buridle Dis. (mm)	Package
FMT-15	75	Φ15	50M/Roll
FMT-20	90	Φ20	
FMT-25	107	Φ25	
FMT-30	123	Φ30	
FMT-40	154	Φ40	
FMT-50	185	Φ50	
FMT-70	248	Φ70	
FMT-100	342	Φ100	

Product updates can be found on the website data

Button Tubes

Description

- Features cable sorting and wire protection, damage prevention from extrusion, chemical corrosion and wea. Features good insulation, aesthetics, and finishing.
- **Thickness: 0.35mm** ■ **Color: Black/Gray**
- **Material:** PVC Double-layered fabric

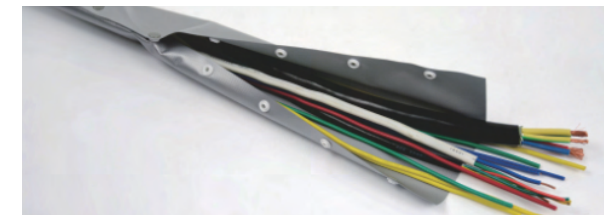
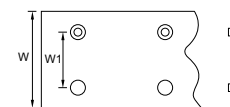

Type	W Band Width (mm)	W1 Buwn Distance (mm)	Max Buridle Dis. (mm)	Package
FBT-10	55	35	Φ10	50M/Roll
FBT-15	75	55	Φ15	
FBT-20	90	70	Φ20	
FBT-25	100	80	Φ25	
FBT-30	115	95	Φ30	
FBT-40	148	128	Φ40	
FBT-50	175	155	Φ50	
FBT-70	242	222	Φ70	
FBT-100	335	315	Φ100	

Type	W Band Width (mm)	W1 Buwn Distance (mm)	Max Buridle Dis. (mm)	Package
FBT-10	55	35	Φ10	50M/Roll
FBT-12	60	40	Φ12	
FBT-15	75	55	Φ15	
FBT-19	80	60	Φ19	
FBT-20	90	70	Φ20	
FBT-25	100	80	Φ25	
FBT-30	115	95	Φ30	
FBT-31	120	100	Φ31	
FBT-3	140	120	Φ37	
FBT-40	148	128	Φ40	
FBT-44	160	140	Φ44	
FBT-50	175	155	Φ50	
FBT-51	180	160	Φ51	
FBT-57	202	182	Φ57	
FBT-60	210	190	Φ60	
FBT-70	242	222	Φ70	
FBT-100	335	315	Φ100	
FBT-1507	495	475	Φ150	



Type	W Band Width (mm)	Buwn Distance (mm)	Max Buridle Dis. (mm)	Package
WB-60	60	40	Φ12	75M/Roll
WB-80	80	60	Φ19	
WB-100	100	80	Φ25	
WB-120	120	100	Φ31	
WB-140	140	120	Φ38	
WB-160	160	140	Φ44	
WB-180	180	160	Φ50	
WB-202	202	182	Φ57	
WB-210	210	190	Φ60	
WB-242	242	222	Φ70	
WB-335	335	315	Φ100	
WB-495	495	475	Φ150	

Product updates can be found on the website data

Business Cooperation



SIEMENS



TOSHIBA



Honeywell

Rockwell Automation



Choose Us

Trust Us